

# Wireless Communication in Automotive Environment (WCAE)

Diary Number: 2013-01285



Project within: FFI Vehicle Development

Author: Magnus Eek, Volvo Car Corporation

Per-Anders Jörgner, Retired from Volvo Car Corporation.

Date: 2018-06-11



## Contents

1.	Executive summary .....	5
2.	Background.....	5
3.	Objectives .....	6
4.	Project realization .....	6
4.1	WP1: Requirements and design verification methods .....	6
4.2	WP2: System design.....	7
4.3	WP3: Dissemination and demonstration.....	7
5.	Results and deliverables .....	9
5.1	Delivery to FFI-goals.....	9
5.2	Examples of Results .....	10
5.2.1	WP1A: Base Technology Specifications .....	10
5.2.2	WP1B: Multipath Propagation Simulator (MPS) .....	14
5.2.3	WP1C: Antenna Measurements.....	22
5.2.4	WP1D: 5.9 GHz Channel Characterization.....	26
5.2.5	WP1E: Verification of Wireless Technologies.....	38
5.2.6	WP2A: Retrofit solution for V2X services based on 802.11p.....	43
5.2.7	WP2B: Integrated Solution for Future Vehicles .....	60
5.2.8	WP2C: User interface for WCAE-enabled services (HMI) .....	67
5.2.9	WP3A: Verification of System in Vehicle .....	74
5.2.10	WP3B: Demonstration of System in Vehicle .....	79
5.2.11	WP3C: Publication of Papers .....	83
6.	Dissemination and publications .....	84
6.1	Knowledge and results dissemination.....	84
6.1.1	WCAE/WV2X Seminar 2015-04-08 .....	84
6.1.2	WCAE/WV2X Demonstration Days 2016-09-28/29.....	85
6.2	Publications .....	87
6.2.1	Journal papers .....	87
6.2.2	Conference papers.....	87
6.2.3	COST IC1004/COST IRACON papers.....	87
6.2.4	Technical report.....	88
6.2.5	Theses .....	88
6.2.6	Related papers from the partners, but where the main work is not directly paid by WCAE: 88	88



7. Conclusions and future research .....	91
8. Participating parties and contact persons.....	91
9. Annex .....	92
9.1 References.....	92
9.2 Terminology.....	92
9.3 Report Authors .....	94



### **FFI in short**

FFI is a partnership between the Swedish government and automotive industry for joint funding of research, innovation and development concentrating on Climate & Environment and Safety. FFI has R&D activities worth approx. €100 million per year, of which half is governmental funding. The background to the investment is that development within road transportation and Swedish automotive industry has big impact for growth. FFI will contribute to the following main goals: Reducing the environmental impact of transport, reducing the number killed and injured in traffic and Strengthening international competitiveness. Currently there are five collaboration programs: **Vehicle Development, Transport Efficiency, Vehicle and Traffic Safety, Energy & Environment and Sustainable Production Technology.**

For more information: [www.vinnova.se/ffi](http://www.vinnova.se/ffi)



## 1. Executive summary

The Wireless Communication in Automotive Environment (WCAE) project commenced in June 2013 and terminated in March 2018. The project was originally planned to terminate in the end of December 2016 but it was prolonged with one year according to a decision in the project's steering group in February 2016. The project management has during the years been handled by AnnSofie Ruuth, Per-Anders Jörgner and Magnus Eek. A special thanks to Per-Anders Jörgner (retired) which has been the main project leader and steered the project in the correct direction.

All project objectives defined in the application were fulfilled and the project will contribute to achieving overall FFI objectives from a wireless communications perspective.

The WCAE project has produced valuable results and knowledge in the areas of cooperative intelligent transport system (C-ITS), 3G, LTE, Wi-Fi and Bluetooth. Research activities and results include wireless simulations, requirements analysis, methods and tools for verification of wireless technologies in automotive, antenna measurements, prototype development and demonstrations. Two key events were the Measurement Campaign in June 2016 and the Demonstration Days in September that year where all project partners contributed, as appropriate.

The project originally consisted of seven partners (VCC, AB Volvo, Actia, Kapsch, SP (now RISE), Lund University and Mecel) but in 2014 Mecel decided (due to changed research strategy in the company) to leave the project. AB Volvo and Actia left the project early 2017 in accordance with the original time schedule and the remaining partners finalized their work in March 2018.

Regarding C-ITS, the project focused on the European set of protocol standards, called ETSI ITS-G5. The American set of C-ITS protocol standards, called WAVE, was covered by an adjacent FFI project called WAVE for V2X (2015-2016), which included a subset of the WCAE project partners. Both WAVE and ITS-G5 are based on the IEEE 802.11p standard for the physical layer.

## 2. Background

When the FFI application was made, in 2013, the following was part of the background to the need for wireless research in automotive [1]:

Real-time wireless communication in the automotive environment is a key enabler to avoid accidents and increase road traffic efficiency, thus focusing on the objectives of the FFI program. Vehicles exchange information wirelessly to cooperatively avoid dangerous situations and enhance the overall road traffic situation, i.e., C-ITS. For example, the enormous accident that took place at Tranarpsbron outside Östra Ljungby, Sweden, in January this year could have been avoided or at least the damages could have been minimized if we already had C-ITS in place.

VCC and AB Volvo have signed a Memorandum of Understanding (MoU) with the OEMs within the Car-2-Car Communication Consortium (C2C-CC) to start deployment of C-ITS in 2015, i.e., the race is on among the OEMs. To speed up and increase the penetration of C-ITS equipped vehicles will both give improved safety, efficiency and competitiveness for our OEMs. One purpose of this project is to study the next generation and new sub-sets of real-time communication technologies (IEEE 802.11p and its European counterpart ITS-G5) but also how to speed up their market introduction.

Telematics and infotainment are currently solely relying on 2G/3G connections to the vehicle. Fast and reliable Internet access to the vehicle is a strong requirement from end customers. With LTE, really high communication rates and spectrum efficient communication can be obtained. However, the new cellular technology implies requirements on efficient antenna solutions and good signal conditions. Therefore, to really benefit from the LTE system, a fixed installation in the vehicle using an external antenna unit is a must. The FFI project ETTE was the first project elaborating with LTE for vehicles; but in rural areas 2G and 3G will be the preferred technologies. Therefore, all three



generations of the cellular systems need to be supported in the vehicle, C-ITS solutions based on 802.11p have to be integrated, and all wireless solutions used in the vehicle must co-exist.

In order to meet tomorrow's demands on the connected vehicle, we need to know if we are designing and building the right thing (validation) and if we are designing and building it right (verification) from a system perspective. To some degree, validation and verification are already performed at, e.g., chipset level for 2G/3G/LTE, Wi-Fi IEEE 802.11 and Bluetooth. There are, however, no requirements on the overall system installed in the vehicle that can be broken down to a component level, which is needed during the design phase. Further, in C-ITS applications based on 802.11p; there is a need for compliance assessment for the whole protocol stack including triggering conditions in hazardous situations when installed in the vehicle. This needs to be further investigated.

### 3. Objectives

The project objectives as defined in the FFI application [1] remained unchanged during the course of the project. As these objectives were defined per WP they are described in conjunction with the project structure in chapter 4 below.

## 4. Project realization

### 4.1 WP1: Requirements and design verification methods

- WP1A: Base Technology Specifications (VCC)
  - Objective: End customers' needs on integrated wireless communication technologies must be broken down to first system requirements and then to component level. By obtaining the component requirements fulfilling the end customers' needs, the OEMs can provide this towards the suppliers.
  - Comments: The requirements process has been significantly improved at both OEMs in this project and the results of this workpackage is now in production at one OEM.
- WP1B: Multipath Propagation Simulator, MPS (SP/RISE)
  - Objective: Replace costly field trials when verifying wireless communication technologies integrated in vehicles.
  - Comments: Development of Multipath Propagation Simulator for large objects has lead to new knowledge with main contribution to research community. We have identified new possibilities, difficulties and limitations in OTA testing of large test objects.
- WP1C: Antenna Measurements (SP/RISE)
  - Objective: Verify radiation performance of the antenna system. Find simplified numerical models that can be used for simulations when investigating antennas for 5.9 GHz.
  - Comments: OEMs has gained new knowlege regarding antenna measurements and the-way-forward regarding antenna design for vehicles.
- WP1D: 5.9 GHz Channel Characterization (LU)
  - Objective: Find channel models and antenna arrangements for performance evaluation of C-ITS applications. Use found channel models in a real-time channel emulator for C-ITS communication verification.



- Comments: The measurement campaign with focus on identify the impact of shadowing effects from other vehicles gave us new knowledge with new input to simulations. We created a channel model including shadowing effects from other vehicles. We identified further research areas which needs to continue.
- WP1E: Verification of Wireless Technologies (VCC)
  - Objective: Find verification methods for complete in-vehicle installation of 3G/LTE/Wi-Fi/802.11p.
  - Comments: We have identified and developed new suitable testmethods and many of them are now are now used by one OEM in production.

## 4.2 WP2: System design

- WP2A: Retrofit solution for V2X services based on 802.11p (Kapsch)
  - Objective: Speed up the number of C-ITS equipped vehicles to quickly see the results of road traffic safety and road traffic efficiency applications.
  - Comments: The development of the comprehensive solutions which includes both requirements on the application level, communication protocols and hardware support has helped all participating parties to progress in this field.
- WP2B: Integrated Solution for Future Vehicles (Actia)
  - Objective: Foster the second generation of integrated AUTOSAR compliant wireless communication platform (WCAE node). Hosting a wide range of services and applications in the following areas: road traffic safety, road traffic efficiency, telematics, infotainment, manufacturing and after-market.
  - Comments: The developed node architecture results shows that the performance can meet the next generations of vehicle architectures. The usage of smart antennas is a strong path to continue to optimize further vehicle designs.
- WP2C: User interface for WCAE-enabled services (AB Volvo)
  - Objective: Elaborate on several different HMI options supporting new types of services enabled through WP2A and WP2B. Provide an HMI-architecture that offers flexibility and supports an iterative development process.
  - Comments: The workpackage has created a smart multimodal HMI design covering a whole range of C-ITS features.

## 4.3 WP3: Dissemination and demonstration

- WP3A: Verification of System in Vehicle (AB Volvo)
  - Objective: Verification of the vehicle installation of WP2A, WP2B and WP2C.
  - Comments: The verification of ITS-G5 day-one use cases (V2X use cases, or applications) with 29 participants from nine different companies lead to a successful campaign regarding all measurements covering phase steerable antenna, 802.11p, LTE and 802.1p together with simultaneously with LTE. Enormous amount of data was collected which has been analysed by project partners for further paper publications, Proof of Concepts, and evidence based data conclusions.
- WP3B: Demonstration of System in Vehicle (AB Volvo)



- Objective: Demonstrate the complete vehicle installation of WP2A, WP2B and WP2C.
- Comments: Dissimination and demonstration day with contribution from multiple workpackages resulted in well equipped vehicles and a successful performed demonstration days.
- WP3C: Publication of Papers (LU)
  - Objective: Disseminate project results.
  - Comments: Multiple journal-, concerence-, COST IC1004/COST IRACON papers, techical report and thesis has been developed through out the years with results which are highly relevant for international research.





## 5. Results and deliverables

### 5.1 Delivery to FFI-goals

The project's contribution to FFI over-arching and sub-program targets/goals were defined as follows in the FFI application [1] (table 3 on page 11):

Targets	Contributions	
	Defined [1]	Actual (at project conclusion)
How well the project satisfies the targets defined within transport, energy and environmental policy	Improve	Potentially improved 1)
The ability of industry to operate knowledge-based production in Sweden in a competitive way	Strengthen	Strengthened
Contribute towards a vehicle industry in Sweden that continues to be competitive	Strengthen	Strengthened
Undertake development initiatives of relevance to industry	Improve	Improved
Lead to industrial technology and competence development	Improve	Improved
Contribute towards secure employment, growth and stronger R&D operations	Strengthen	Strengthened
Contribute towards actual improvements being made to production at participating companies	Strengthen	Potentially strengthened 1)
Strengthen research environments in selected, prioritized research areas in the field of production technology	Neutral	Neutral
Support environments for innovation and collaboration	Strengthen	Partially strengthened 2)
Strive to ensure that new knowledge is developed and implemented, and that existing knowledge is implemented in industrial applications	Strengthen	Potentially strengthened 1)
Rationalize the application of R&D results so that actual production improvements are implemented in participating companies	Neutral	Neutral
Improve the quality of technical production training	Neutral	Neutral
Reinforce collaboration between the vehicle industry on the one hand and the Swedish Road Administration, universities, colleges and research institutes on the other	Strengthen	Partially strengthened 2)
Strive to secure national supplies of competence and to establish R&D with competitive strength on an international level	Improved	Partially Improved 2)

Comments:

- 1) Will be determined when the project partners have eventually introduced WCAE-based products on the market.
- 2) The project consisted of a very good mix of industry partners – two OEMs (VCC and AB Volvo) and three suppliers (Actia, Kapsch and Mecel) – one research institute (SP/RISE) and one university (Lund).



## 5.2 Examples of Results

### 5.2.1 WP1A: Base Technology Specifications

#### 5.2.1.1 Activities Performed

The main task of the workpackage was to define requirements and design verification methods, which has been performed for a various set of wireless technologies, such as Wi-Fi, LTE, V2X ITS G5 and Wireless Co-existence.

The workpackage has been working iterative with the following tasks:

- Literature study to identify customer needs for wireless technologies today and in the future, using Design For Six Sigma (DFSS).
- Literature study and meetings with market, to learn how the standardization work is done versus the real implementation by semiconductor industry.
- Transfer our internal consumer requirements into technical requirements.
- Experiments and education on DFSS to perform better product design has been performed to identify the wireless performance effects from tuning different OSI layer for vehicles in standstill and moving in real environments.

#### 5.2.1.2 Wireless System Analysis

For each of the technologies mentioned in WP1A, we have investigated different factors that affect the wireless system. The transformation of customer requirements into technical system requirements is important and is mainly been done by:

- Developing mathematical model (transfer function), if needed.
- Perform system simulations.
- Study technical standards and study real implementations.

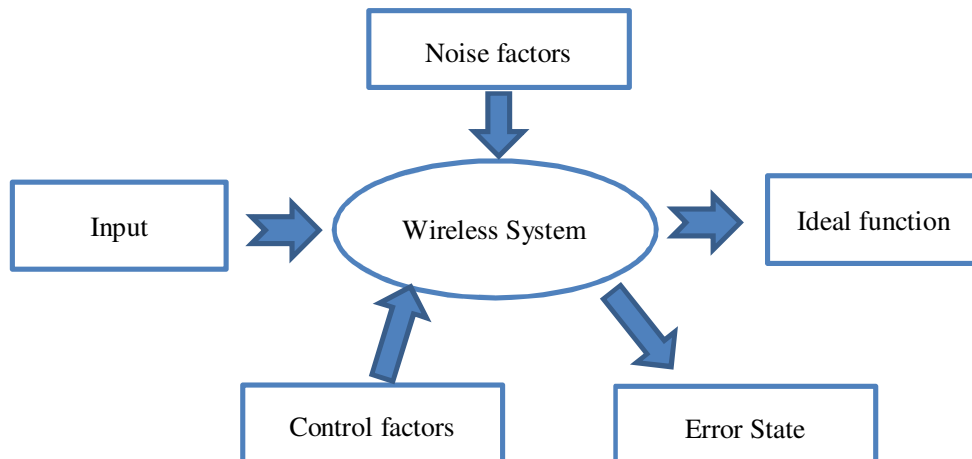

Figure 1 Wireless system analysis



#### 5.2.1.2.1 Input - Transfer customer requirements

We have gained understanding and new knowledge on how to transfer customer requirements into technical requirements.

#### 5.2.1.2.2 Noise factors

We have investigated the influence of various noise factors, such as surrounding environments, electromagnetic signals, and co-existing technologies for each wireless system.

#### 5.2.1.2.3 Control factors

We have been studying the IEEE, ETSI, SAE, 3GPP standards and profiled specifications developed by the industrial alliances such as WiFi-Alliance, C2C-CC and so forth to select and define the control factors.

##### 5.2.1.2.3.1 Wireless system controlfactors

In our work to design a good wireless system, we addressed the linkbudget calculation for the different use-cases with vehicle internal communication and external vehicle communication. As the figure below presents, we have considered TX Power and RX Sensitivity, cable loss, 3D antenna diagram, noise and fading margin and of course the regulatory E.I.R.P (Effective Isotropic Radiated Power).

#### 5.2.1.2.4 Error state

When the wireless system fails to provide the ideal function (e.g. out of communication range).

#### 5.2.1.2.5 Ideal function

When the wireless system succeeds in providing conditions for the use case to work as defined.

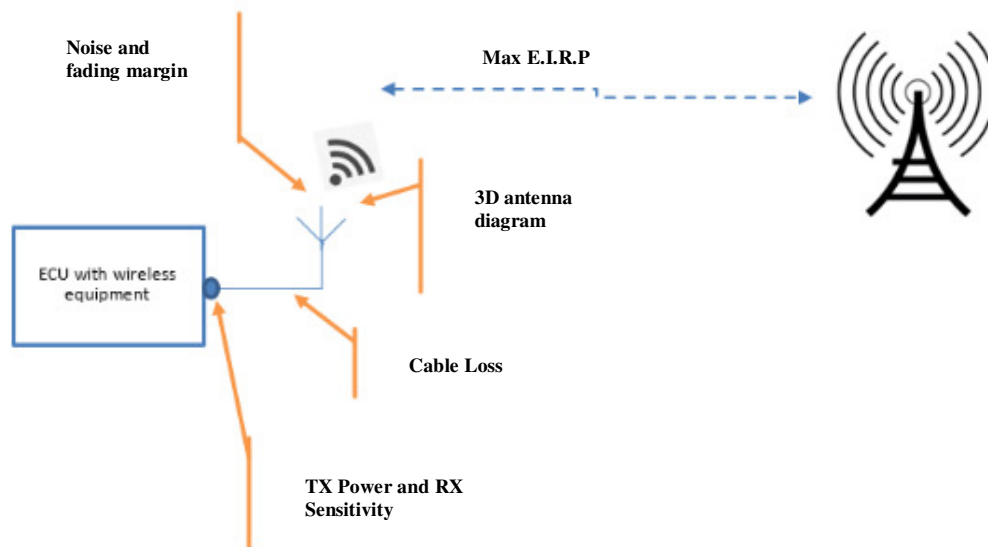

Figure 2 Wireless system controlfactors



5.2.1.2.6 Example of transfer customer requirements into technical requirements:

Use-case: In-Vehicle application support for Wi-Fi tethering of videostreams consuming 6 MBps of bandwidth.

Study: To study if the wireless system can support the use-case, we focus on the control factors (e.g. communication protocol, TX output power, RX sensitivity, communication stack) and consider the noise factors (electromagnetic signal, surrounding environment). As a result from all these parameters, we get either the ideal function or an error state in the wireless system. The error state can be caused by angular dependencies in range, out of range, interrupt in transmission or transmission is slow.

The transformation process starts with the definition phase where we identify the critical x-values.

**Definition phase**

$$Y = f(x)$$

**Vehicle critical x-values**

$$Y=f(X_1, X_2, X_3... X_n)$$

Y = Vehicle with application using Wi-Fi

X<sub>1</sub>= ECU equipped with Wi-F functionality, X<sub>2</sub>= Quality, X<sub>3</sub>= Price

**Functional x-values (X<sub>1</sub> = ECU equipped with Wi-F functionality)**

$$Y'=f(X_1, X_2, X_3... X_n)$$

Y' = ECU equipped with Wi-F functionality

X<sub>1</sub>= SoC (System on Chip) – CPU, X<sub>2</sub>= TCP/IP Communication stack, X<sub>3</sub>= Operating System, X<sub>4</sub>= Memory handling, X<sub>5</sub>= Transceiver drivers, X<sub>6</sub>= Transceiver (NIC), X<sub>7</sub>= Antenna cable, X<sub>8</sub>= Vehicle Wi-Fi antenna(s), X<sub>9</sub>= Application design (drivers and applications)

A crucial step in the process is breaking down the wireless system into components. This allows us to identify that network and transport layers (in addition to physical and datalink layers) also plays an important role in system performance. The figure below highlights this by showing a software overview of an ECU (Electronic Control Unit) from a network and transport layer perspective.

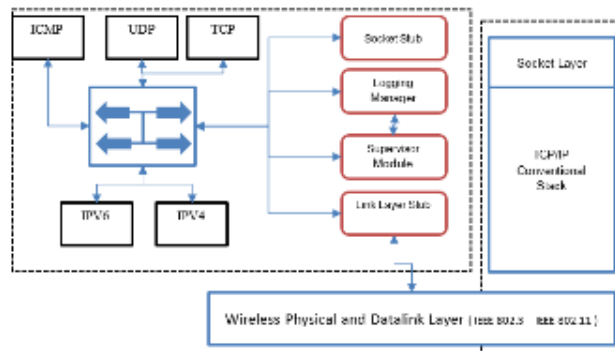

Figure 3 Software overview of a ECU equipped with Wi-Fi



### 5.2.1.3 WP1A Results

Following the methodology defined above, a number of Volvo Cars requirement specifications, including design verification methods, have been developed and used by our vehicle projects in production for the SPA platform. They are listed in the references and the results in WP1A work is defined in these.

### 5.2.1.4 WP1A Conclusions & Future Research

#### *Conclusions*

We have learned the importance of addressing both the hardware and software implementations together from a system perspective, and not only focus on good hardware components (transceiver, antennas and good placement of them).

Additionally, we have learned about in-vehicle wireless systems and the effect of mobility on the system performance.

- We have performed deep investigations on the standards (IEEE 802.11, 3GPP, ETSI ITS G5, available transceivers, antenna solutions, software applications, security solutions and identified a set of requirements (gaps from the standard) which are important and that we as an OEM needs to define.
- We have reviewed the markets conformance & interoperability tests. Technologies offers test-suits to ensure interoperability and conformance, to ensure that we all design a wireless system that can operate with as low amount of error states as possible.
- We have performed practical experiments analysing the network protocol stack features and the consequence on the hardware/software implementation.
- We have learned how to transfer customer requirements into technical requirements, while keeping in mind the effect of most critical control and noise factors.
- Co-existence where wireless devices on the same band or adjacent band interfere with each other, and we have identified solutions to limit the issue.

#### *Future research*

- We will continue focusing on new wireless technologies and try to understand how we can use them in the future.

### 5.2.1.5 WP1A References

- [1] WLAN Physical and Datalink Layer
- [2] LTE Physical and Datalink Layer
- [3] Wireless Co-existence
- [4] WLAN V2X ITS G5 Physical and Datalink Layer
- [5] WLAN V2X ITS G5 Network to Facility Layer

## 5.2.2 WP1B: Multipath Propagation Simulator (MPS)

### 5.2.2.1 Activities Performed

The WP was led by RISE in cooperation with Volvo Car Corporation, ACTIA Nordic, and towards the end of the project also Keysight (initially Anite, but this company was during the project taken over by Keysight).

The following main tasks were performed:

- Completed Multipath Propagation Simulator (MPS) hardware.
- Development of test setup for LTE, Wi-Fi and V2X with the MPS.
- OTA multi-probe measurements on LTE node in vehicle with MPS.
- OTA multi-probe measurements on LTE node in vehicle with Keysight channel emulator PropSim.
- Development of the Wireless Cable (WC) test setup for LTE node in vehicle with PropSim.

### 5.2.2.2 Results

Over-the-Air (OTA) multi-probe setup is a technique originally used for characterizing wireless devices (e.g. mobile phones). In this setup the signal is sent to the Device Under Test (DUT) by distributing the signal over an array of antennas encircling the test object, see Figure 4. When building an OTA multi-probe setup simulator the antenna array should be an optimal design with respect to:

- The characteristics of the test objects
- The parameters to be measured
- The desired measurement accuracy

Performing measurements on a car by using an OTA multi-probe setup has not been done prior to this project and to enable such this WP has developed and validated a MPS with related equipment and tools. Towards the end of the project new challenges were found and to advance the area further, contact was made with Anite (now transferred into Keysight) for implementation and validation of the novel WC method.

The main contribution to research community is our experiments and analysis on the influence a large test object (as a car) has on an OTA multi-probe setup.

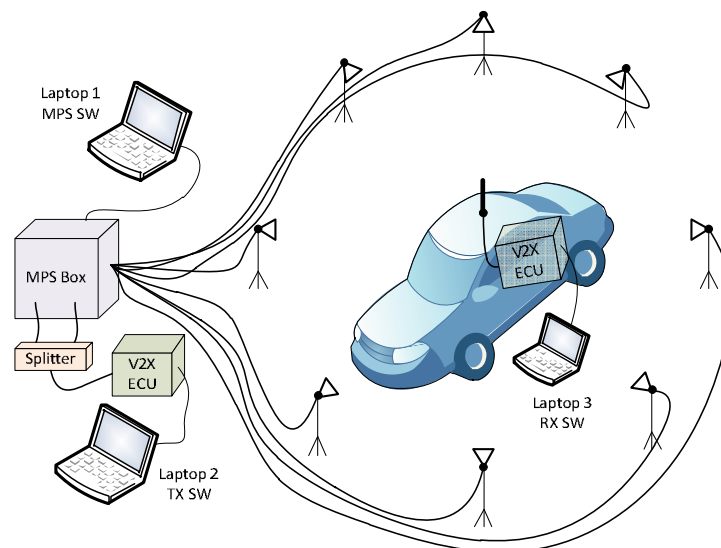

Figure 4 OTA multi-probe setup with the MPS box for V2X (IEEE 802.11p) test

### 5.2.2.3 Completed MPS hardware and tools

The MPS is a channel emulator tool aiming to enable repeatable uni-directional OTA testing in lab environment. Its capabilities are defined by its hardware and it is in the present version equipped with eight independent RF paths in the frequency range 0.7-6 GHz. It has two input ports in the front enabling up to 2X2 unidirectional MIMO (SISO, MISO, SIMO or MIMO). During test of wireless system it is connected to a base station simulator or equivalent at one side and up to eight antennas transmitting to the DUT on the other side. To run the tests a control software for a base station simulator has been developed [3] enabling, e.g., control and logging of Block Error Rate (BLER), transmit and received power. A block diagram of the MPS is shown in Figure 5 pointing out control signals, fibre loops for delay, phase shifters, variable attenuators, and finally RF amplifiers amplifying the signal before it is send further to the transmitting antennas encircling the DUT (Figure 4). In Figure 2Figure 6 the exterior as well as some of the interior of the MPS is shown.

An old MPS was used as input to the project and during the work the MPS has been further developed with wideband and RF shielded phase shifters, phase shifter calibrations, new controller cards and new control software. Regarding the wideband phase shifters, such were not present on the market prior to this project and are therefore designed and developed in this WP. The OTA multi-probe setup built in the project has the following specifications:

- Frequency range 0.7 - 6 GHz
- Excess delay spread, 0 to 5  $\mu$ s
- Channel attenuation, 0 - 90 dB
- Doppler shifts, 0 to  $\pm 2$  kHz
- Fast fading (generated by random phase initialization per path)
- Angular distribution (set by antenna placement in chamber)
- Polarization distribution (set by antenna orientation in chamber)
- Variable radius, e.g.: 5 m

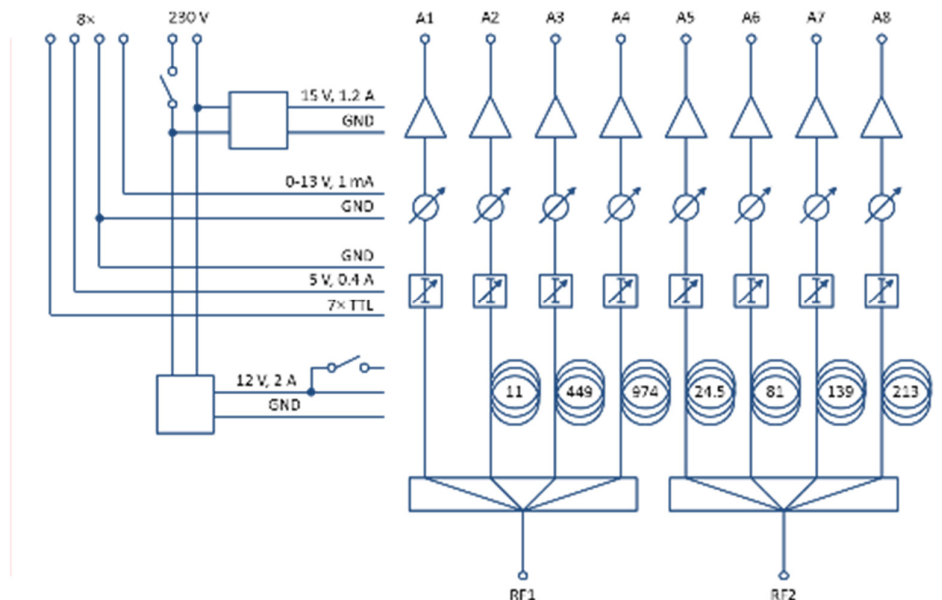

Figure 5 Block diagram of the MPS

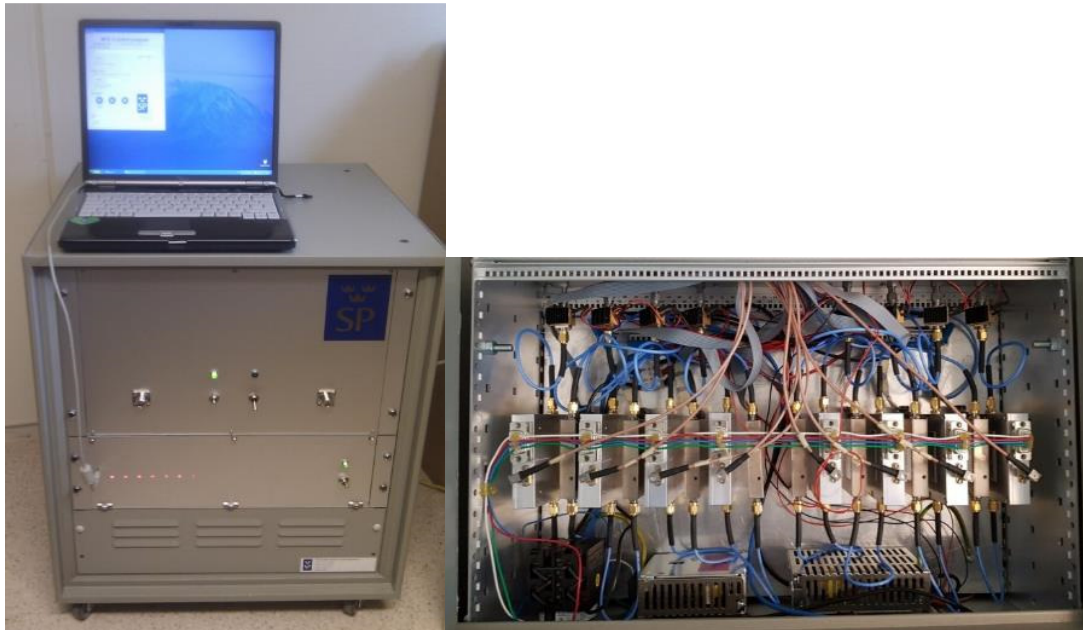

Figure 6 Left: Exterior of the MPS including computer with “MPS control software”. Right: Interior of the MPS, two floors in a 19" rack mount case. The upper floor is shown in the picture with power supply, phase shifters, controllable step attenuators, and RF amplifiers. The lower floor (not visible here) contains fibre loops for delay and controller boards.

### Phase shifters

Wideband phase shifters have been developed in the project. Those mainly consists of two RF switches for frequency band selection, three MMIC phase shifters in different frequency bands to cover 0.7-6GHz, and communication with the controller board for setting of carrier frequency and Doppler frequency. The picture shows the phase shifter in its final mount inside a specially made shielding box, which is necessary for isolating the individual signal paths during OTA test.



### Controller board

The controller boards control the phase shifters and the attenuators. Communication with the “MPS control software” is bi-directional and is enabled over a USB-serial communication.

To output linear phase variations the controller boards have stored calibration curves derived from precise characterization of the analog hardware.

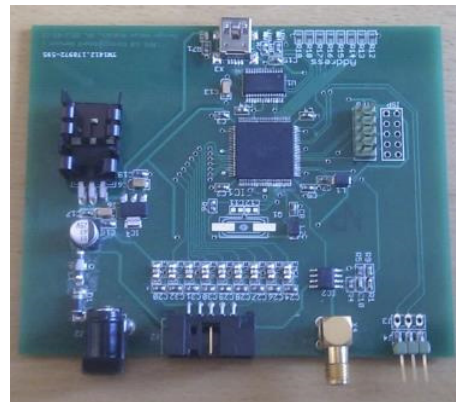





### Dual polarised antennas

OTA testing is performed with channel models described by 3GPP which requires incoming waves from different directions in both vertical as well as horizontal polarisation. To fulfil this requirement a set of dual polarised Vivaldi antennas was developed and characterised [6].

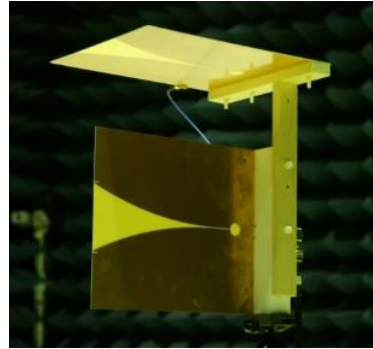

### MPS control software

The MPS is a complex instrumentation which requires a lot of settings to emulate a real environment in the lab. (Each signal path has to be fed with correct amount of power, delay and Doppler frequency). To make testing feasible and repeatable a configuration software tool was developed. Besides the properties mentioned above the tool enables calibration of the phase shifters, definition of channel models, link budget calculation and three types of phase shifts (saw-tooth, triangle, negative saw-tooth).

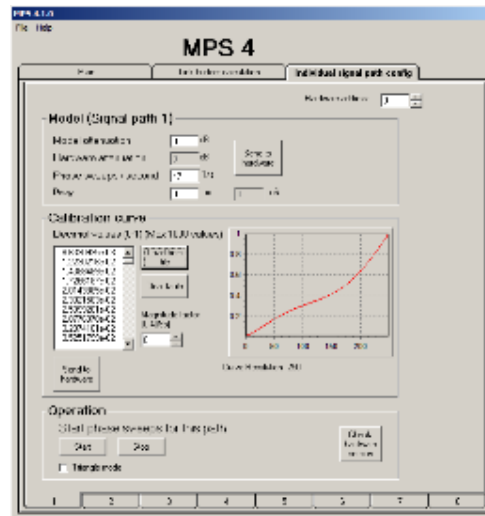

### MPS simulator

To analyse how the field, which is a superposition of the radiated fields from the antennas in the test, depend on the OTA test settings a MATLAB script for simulating the emulation environment was developed [7]. In the tool influence from antenna placements, carrier frequencies, Doppler shifts and other properties of the MPS can be examined. The upper figure shows field distribution at one time instant when eight evenly spaced antennas encircling the DUT are excited at 700 MHz with Doppler frequencies linearly spaced from 100 to 800 Hz. The same setup is shown in the lower figure, but now over frequency in one spatial point in the middle of the antenna ring (observation point: 0, 0). Here it is studied how the Doppler spectrum is affected by different phase shifter control.

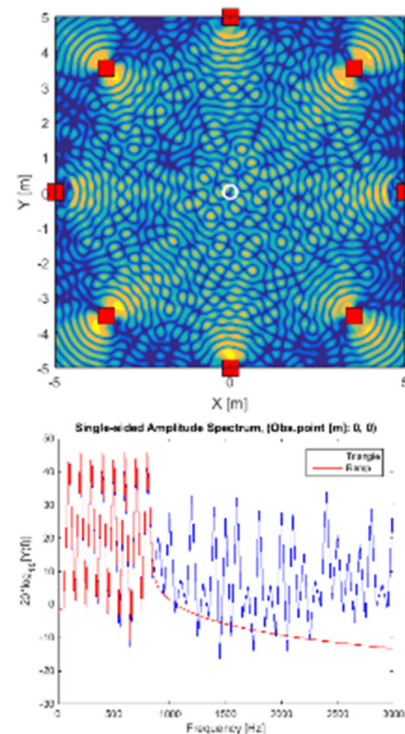

### 5.2.2.4 MPS test system

The MPS has been used for tests on several different vehicles, antenna modules, wireless systems, and in different test facilities such as RISE Faraday semi-anechoic chamber (see Figure 7) and Störmätplatsen at VCC. A manual for the MPS can be found in [1], measurement setup in [6], and measurement uncertainty, channel simulation and disturbance characterization has been investigated in [4].

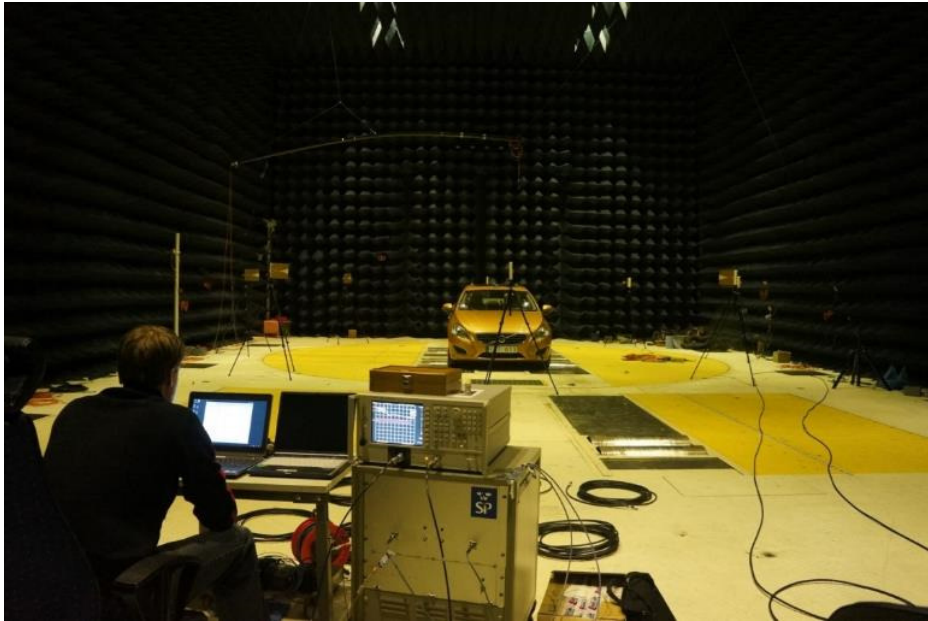
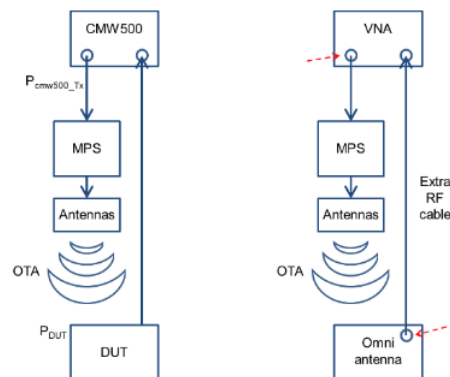

Figure 7 Test at RISE/Faraday semi-anechoic chamber with the operator and the MPS in the foreground and the test object surrounded by eight antennas in the background

### MPS test system calibration and verification

Left: schematic of the setup during test with base station simulator, MPS, antennas and DUT.

Right: Schematic of the calibration setup with Vector Network Analyser (VNA), MPS, antennas and omni-directional antenna.





**Delays**

VNA time domain measurement verifying the delays in the measurement setup. Delays appear at proper time locations.

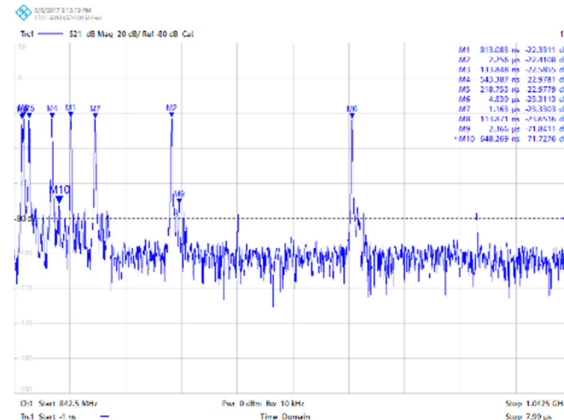

**Doppler shift**

Evaluation of phase shifter with RUSK channel sounder in Lund [2]. Doppler is set to 400 Hz at a carrier frequency of 5.9 GHz. The plot shows data from one active signal path and the predicted Doppler frequency is verified.

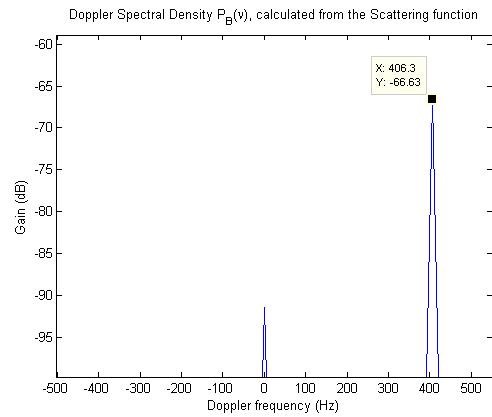

**Example of results**

BLER as function of received power for a TCAM antenna module on a XC90. This test is performed on LTE band 3 with QAM modulation and for the 3GPP Uma channel model. In the measurements discontinuities or glitches are found, which could be due to deficiencies of the test system (i.e. analog phase shifters).

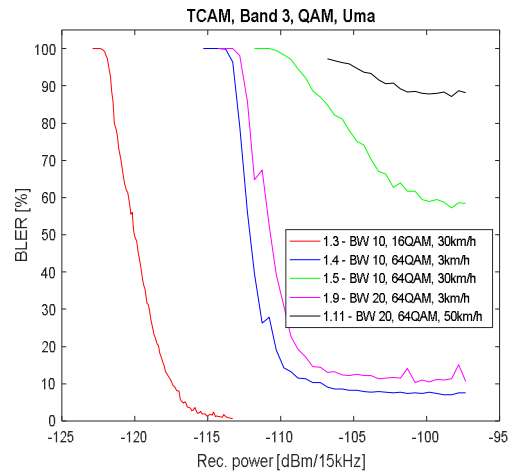

### 5.2.2.5 Keysight cooperation

Towards the end of the project cooperation was initiated with Keysight. Reasons for that were threefold:

- Classical OTA rings requires a quite zone if, e.g., MIMO in correlated channel is to be investigated. Such is not possible if the test object destroys the quite zone, which often is the case for large test objects such as cars. Therefore we need to develop a new concept, which is not test zone dependent anymore.
- To go from basic research to advanced engineering for testing car connectivity.
- The MPS is capable of the tests described in the application, but for extension to future wireless standards, channel models and new test cases functionality it is limited to installed hardware.

RISE and VCC went to the Keysight plant in Oulu for measurement of a shark-fin antenna module (MAM) and later on Keysight brought their equipment (PropSim) to RISE for validation tests of the WC method. The project has participated in development and validation of this novel method which has an advantage over classical OTA methods when it comes to large test objects such as cars.

#### Keysight plant in Oulu

To the right the test setup in anechoic chamber at Keysight plant in Oulu, Finland is shown. Dual polarised antennas (white crosses) encircle the DUT consisting of a titled metal ground plane with a MAM antenna module.

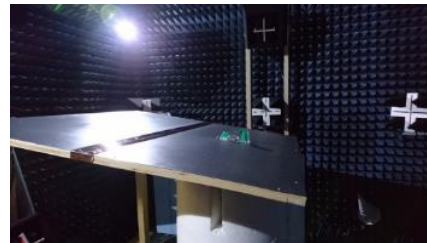

#### Calibration of test setups

The WC method requires radiation patterns of the DUT. Several DUT's were calibrated during the WP and here calibration of a test setup consisting of two MAM antenna modules is shown.





### RISE/Faraday semi-anechoic chamber

XC90 positioned for WC test using PropSim channel emulator in RISE/Faraday semi-anechoic chamber.



### Example of results

Results from the verification measurements using the PropSim channel emulator in RISE large semi-anechoic chamber and real car with MAM antenna module as test object. The WC method agreed well with standard OTA method for MAM mounted on an XC90 for two different 3GPP channel models (UMi and UMa).

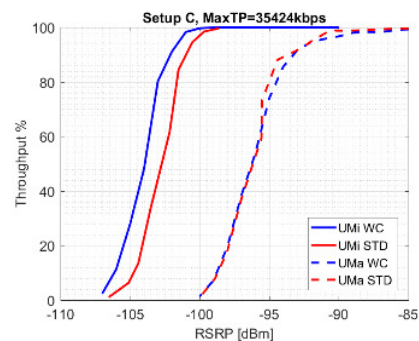

### 5.2.2.6 Conclusions & Future Research

The project members have learned a lot in possibilities, difficulties and limitations in OTA testing of large test objects such as cars. For future research the MPS is limited by its hardware implementation and for future studies professional equipment has been invested in by RISE. Without the knowledge earned in this project such investment would not have been possible.

### 5.2.2.7 WP1B References

- [1] N. Arabäck, K. Karlsson, "Multi-path Propagation Simulator (MPS) manual," Borås, 2016.
- [2] M. Nilsson, "Channel Sounder Measurement on Multipath Propagation Simulator for IEEE 802.11p Communication," VCC test report, Issue date: 141125, Issue: 4.
- [3] K. Karlsson, "CMW 500 Control software," Borås 2016.
- [4] M. G. Nilsson, P. Hallbjörner, N. Arabäck, B. Bergqvist, T. Abbas and F. Tufvesson, "Measurement Uncertainty, Channel Simulation, and Disturbance Characterization of an Over-the-Air Multiprobe Setup for Cars at 5.9 GHz," in IEEE Transactions on Industrial Electronics, vol. 62, no. 12, pp. 7859-7869, Dec. 2015.
- [5] P. Hallbjörner, "Multipath Propagation Simulator Antenna – Design and Electrical Performance," Borås, 2012.
- [6] K. Karlsson, N. Arabäck, P. Hallbjörner, "MPS measurement setup," Borås 2018.
- [7] K. Karlsson, "MPS simulator," Borås 2018.



## 5.2.3 WP1C: Antenna Measurements

### 5.2.3.1 Activities performed

The objective of WP 1C was to:

- Verify radiation performance of the antenna system.
- Find simplified numerical models that can be used for simulations when investigating antennas for 5.9 GHz.

### 5.2.3.2 Antenna measurements and implementation of antenna measurements

Two reports discuss antenna characterisation in general [1] and what methods that are suitable for vehicle measurements [5]. Due to the limited size of the measurement site a short measurement distance is required. This means measurements in the nearfield where the antenna diagram depends on the distance. An established method is a detailed measurement including phase over a defined surface (square plane, cylinder or sphere). The result can then be numerically transformed to any distance including farfield – a nearfield to farfield transformation.

A nearfield range for spherical measurements is the preferred choice for vehicle measurements. It can be built as an open site or inside an anechoic chamber (Figure 8).

A specific challenge is multi element antenna systems that can improve performance with diversity or MIMO functionality. The function of the signal processing then must be added to the antenna diagrams for a full understanding of the antenna system properties.

It shall be noted that it is required to use the antenna connector for transmitting specific test signals something that that might be impossible if the antenna is integrated with the transceiver.

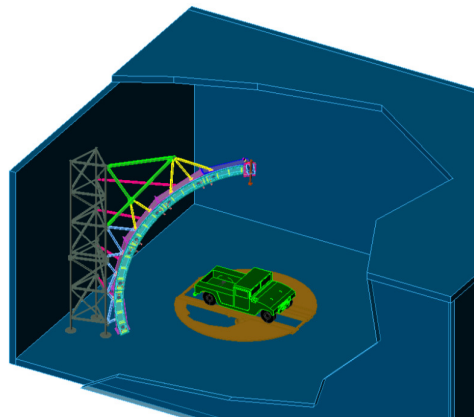

Figure 8 Example of a nearfield measurement range (NSI)

### 5.2.3.3 Methods and rules for model simplification

A study was carried out to see how complex a simulation model needs to be and still give an acceptable simulation result [2]. In a simulation model the object is discretized into small cells. The cell size is depending on the frequency and for high frequencies the number of cells becomes very large. The memory of a standard computer will not be sufficient and the amount of processing grows faster than the number of cells. The way to reduce the model to an easily manageable size is to include only include the parts of the vehicle that influences the antenna diagram.

Figure 9 shows a model reduced to the roof only that still gave an acceptable simulation result for a shark fin at 2100 MHz compared to a full vehicle body. The difference in maximum antenna gain was 0.8 dB. Reduction to a flat roof sized ground plane gave a too large deviation (5 dB).

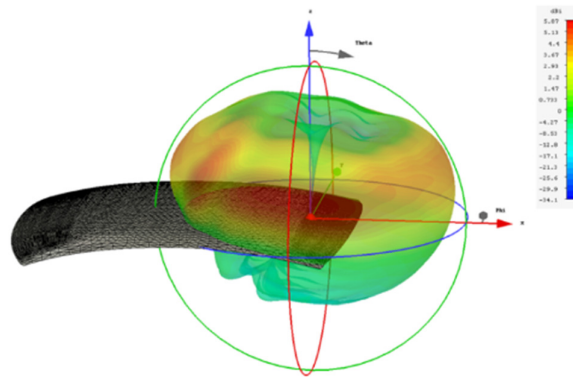

Figure 9 Simulation of shark fin. Reducing the complete vehicle to the roof only gives only a minor difference in the simulation result

#### 5.2.3.4 Radiation pattern measurement of antennas mounted on vehicles

A large number of antenna measurements on actual vehicles were made and presented in 2D-diagrams. The horizontal plane and an elevation angles were selected [3]. Several different types of antennas were measured on different vehicles. The systems in mind were 3G/LTE, WiFi and 802.11p.

The measurements were carried out in a chamber with metallic floor with installations creating complicated reflections patterns. A typical diagram is shown in Figure 11 (together with a simulation).

Time gating was chosen to reduce the influence of unwanted reflections. This is demonstrated in Figure 10 where an impulse response is calculated from a measured frequency sweep. The marked part between 25.5 ns and 28.5 ns can be used to estimate the direct signal. The signals before 25.5 ns are noise and the signals after 28.5 ns are unwanted reflections. A method validation showed that the error is in the region 0.2 – 0.4 dB.

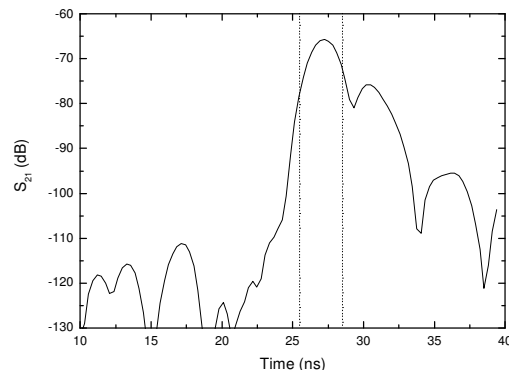

Figure 10 Impulse response of the measurement signal showing noise (<25 ns) and reflections (>28 ns). The response is calculated from a frequency sweep.

#### 5.2.3.5 Comparison simulation-measurements

The two reports on simplification of simulation models [2] and vehicle antenna measurements [3] are base for a comparison presented in [4].

The compared antennas were two monopoles mounted on a small square ground plane on a vehicle roof. The simulations also included a shark fin but this was not compared with measurements. In the measurements the time gating method was used [3]. Four elevation angles  $0^\circ$  -  $15^\circ$  and two



frequencies, in total 8 cases, were measured. The simulations were carried out using CST Microwave Studio time domain solver.

A typical result is shown in Figure 11 representing 10° elevation and 2002 MHz. The maximum difference was 2.77 dB and the standard deviation 0.87 dB. The values for the other cases are similar.

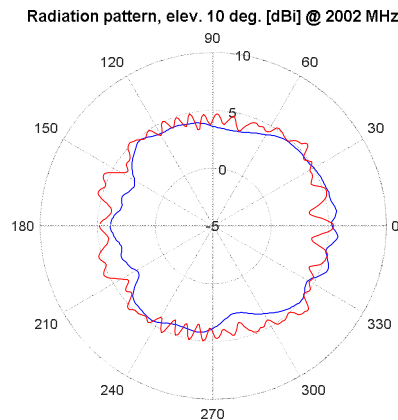

Figure 11 Comparison measurements – simulations. The maximum difference is 2.77 dB.

#### 5.2.3.6 Results

A number of reports have been compiled in WPIC. They are listed in the references.

The main results in the reports are:

WPIC D1. An overview presenting possible antenna measurement procedures.

WPIC D2. The study dealt with modelling shark fin antennas and shows that reducing the vehicle model to the roof only is possible with only minor differences in the antenna diagram.

WPIC D4. The radiation pattern measurements show the feasibility of time gating for antenna measurements. This means that antenna measurements with good accuracy can be performed in an environment that otherwise not is suitable for antenna measurements.

WPIC D5. The comparison between simulations and measurements show a fairly good agreement between simplified simulations models and time gated measurements.

WPIC D7. Discussions of the possibilities to implement antenna measurements in laboratories at RISE or in a new measurement site. The possible levels of investment have a wide span from using existing equipment for simple measurements up to a completely new anechoic chamber.





### **5.2.3.7 Conclusions & Future Research**

#### Conclusions

- Time gating can improve antenna measurements substantially in otherwise not suitable environments
- Simulations models can be reduced from a complete vehicle to e.g. the roof to save modelling and computation time

#### Future research

- Antenna diagrams for large vehicles. Antenna diagrams of very large vehicles like trucks with trailers and busses cannot be measured on normal measurements sites. An alternative measurement methods needs to be developed.

### **5.2.3.8 WP1C References**

- [1] WP1C D1 Antenna measurements
- [2] WP1C D2 Methods and rules for model simplification
- [3] WP1C D4 Radiation pattern measurement of antennas mounted on vehicle
- [4] WP1C D5 Comparison simulation-measurements
- [5] WP1C D7 Implementation of antenna measurements (PowerPoint)



## 5.2.4 WP1D: 5.9 GHz Channel Characterization

### 5.2.4.1 Activities Performed

Within WP1D the main focus has been on measurement based channel characterization so that the vehicular channel can be modelled with a network perspective, or link perspective, in mind. As input to the characterization efforts there were three main measurement campaigns, especially focusing on multilink aspects and shadowing effects. The first measurement campaign was performed in Lund/Malmö in November 2013 involving two cars and one truck. The second campaign was mainly performed on the highway between Göteborg and Borås and involved four cars. The third campaign was performed with two trucks and four cars and contained measurements both in urban scenarios in the center of Göteborg as well as highway scenarios between Göteborg and Borås. Besides this we have also got access to some extremely wideband measurements performed in Berlin by Heinrich Hertz institute. The input from this has been used for detailed characterization of scattering processes in urban intersections and then for the detailed simulation model for such scenarios.

For the first campaign, the measurements were done with the RUSK Lund channel sounder in two of the vehicles, whereas the latter two campaigns were performed with Kapsch EVK 3300 evaluation in all of the involved vehicles, thereby enabling simultaneous measurements between *all* of them. Below we describe the main results, divided into four parts: Shadowing effects from trucks, multilink behaviour in highway scenarios, multilink behaviour in urban intersections, and real time emulation of V2V channels.

### 5.2.4.2 Results

#### 5.2.4.2.1 Shadowing effects from trucks

Trucks and larger vehicles constitute natural shadowing objects in the vehicular environment. Unlike the case in cellular systems, the shadowing objects in the vehicular case tend to cause shadowing for a long time period due to the mobility patterns. Therefore it is important to understand the physical process and the effect of shadowing from other vehicles in V2V scenarios. We have characterized the influence of a truck by channel measurements between two cars with a larger vehicle in between in different scenarios, see Figure 12.



*Figure 12. Characterization of the influence of trucks and larger objects on the V2V link between the Tx and Rx cars. The Tx car is here equipped with 6 antennas at various positions.*

The link properties are investigated in detail in [11]. It was observed that the line-of-sight (LOS) and obstructed line-of-sight (OLOS) links show fundamentally different behavior. For the LOS case there is a clear two path pattern due to the ground reflection. For some certain distances, there are deterministic dips due to the interaction between the direct path and the road reflection. In the OLOS case there is additional loss due to the shadowing, but no clear two-path behavior, see Figure 13.

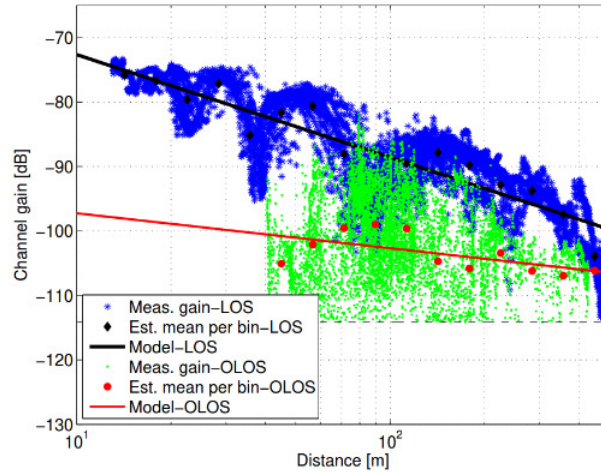

Figure 13. Line-of-sight (LOS) and obstructed line-of-sight (OLOS) channel gain. For the LOS case there is a clear two-path behavior, whereas the additional loss due to the truck is clearly visible in the OLOS case.

The additional loss can be described as a log-normal random variable with an exponential auto-correlation function. For the highway scenario the mean loss was 12.7 dB for the standard shark fin antenna with a standard deviation of 6.7 dB. In the rural case the values were in the same range, 11.9 dB mean loss with a standard deviation of 5.2 dB. Figure 14 below shows the extracted and modelled shadowing loss in a highway scenario for the shark-fin antenna.

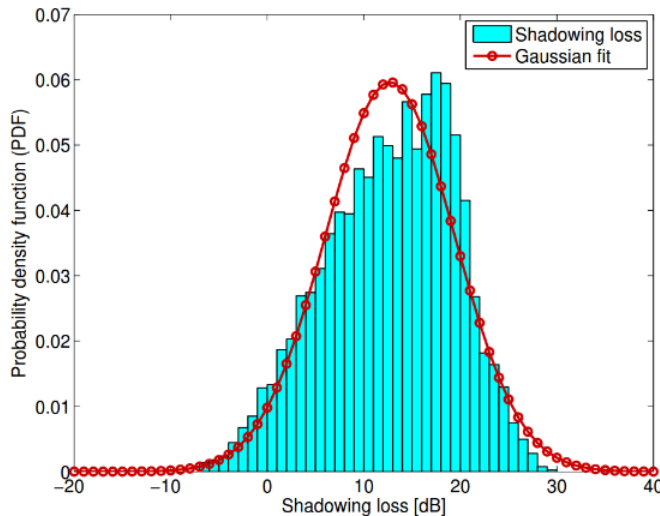

Figure 14. Shadowing loss due to the presence of the truck in a highway scenario.

To get a better understanding of the shadow fading behaviour, we created a theoretical model assuming that the truck could be described as two travelling screens with dimensions determined by the physical size of the truck [6]. Considering all major paths due to diffraction and road interaction, as in Figure 15, there will be a fading pattern behind the truck depending on the exact relation to the center axis and the distance to the truck. Figure 16 below shows an example of how a snapshot of this fading pattern may look like for different positions behind the truck.

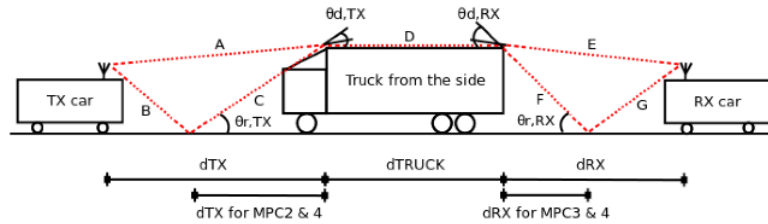

Figure 15. Theoretical model for diffraction around a truck

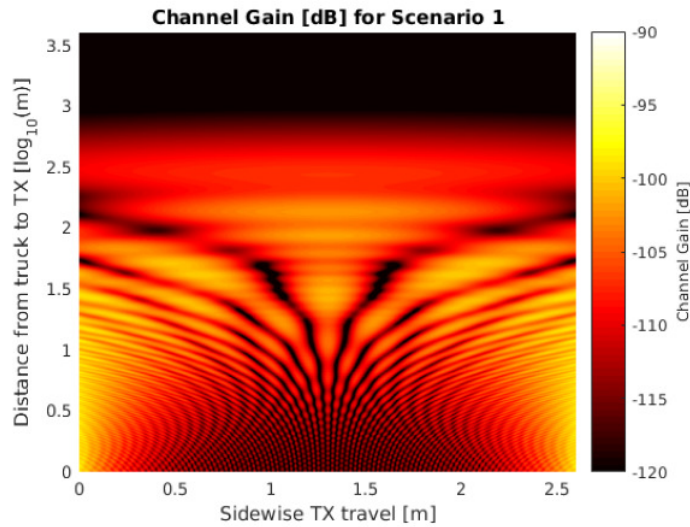

Figure 16. Fading pattern due to the interaction of different diffraction components behind the truck.

As seen in the figure there are dips in the order of 20 dB just due to the interaction of different diffraction components. This kind of fading can in a straightforward manner be mitigated with diversity antennas at the communicating vehicles.

5.2.4.2.2 Multilink modelling in highway scenarios

Often in V2V simulations only a single link between two vehicles are considered, but many practical use cases involve several simultaneous vehicles. For proper modelling, and later on also simulations, it is important to model bot the auto-correlation in time as well as the cross-correlation between links of different vehicles, in e.g. a platoon. The multi-link case was essentially not investigated at all in previous studies in the literature, despite its importance, and hence we performed a multilink measurement campaign with the goal of more realistic channel model for those cases. The vehicles used are shown in Figure 17.

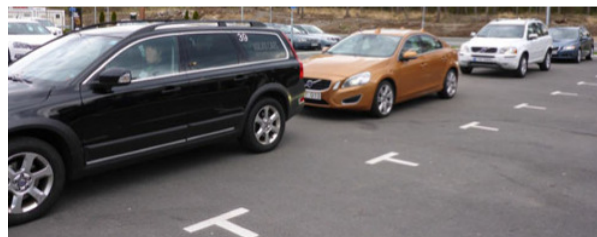

Figure 17. Vehicles for the multilink channel characterization



As in the previous measurements, we identified a clear two path behavior in LOS, and decided to use this for the LOS model, see [3] for details.

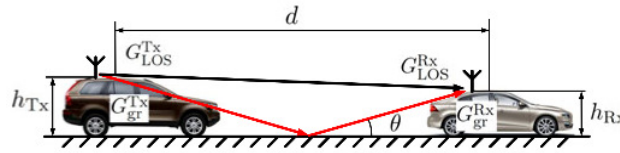

Figure 18. Two-path model for LOS communication

Figure 19 shows an example of the modelled and measured channel gain.

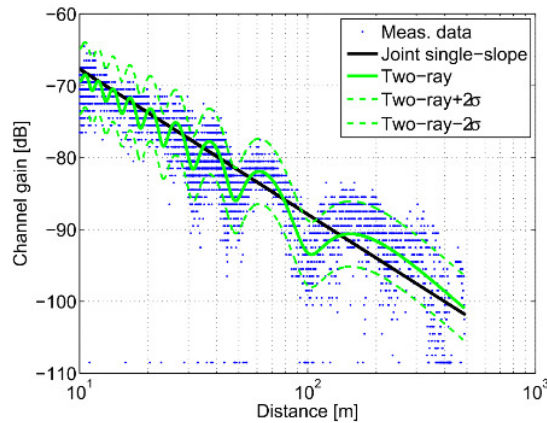

Figure 19. Measured and modelled channel gain for the LOS case.

For the OLOS case we decided for a link dependent single slope model. The link dependence has several reasons and it is important to consider natural variations in vehicle designs when performing simulations. Different vehicles have different antenna gains, antenna patterns, vehicle bodies etc meaning that there are variations of several dBs between vehicles, but also even larger variations due to the antenna pattern and the current angle of departure/arrival.

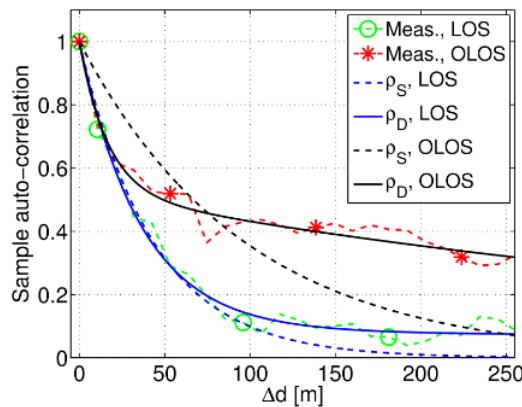

Figure 20. Auto-correlation for the large scale fading process.

The pathloss model applied has a large impact when estimating the correlation functions. The basis for the estimation of the large scale fading should be a pathloss model that accurately reflects the large scale fading mean and standard deviation for each link separately. Our findings show that a two-ray model for LOS and a single slope model for OLOS are appropriate ones, with those we saw a decorrelation distance of 24 m for the large scale fading. For the same reason we suggest a geometry



based model to deal with cross-correlation effects. If shadowing effects are dealt with properly by a geometrical model, the cross-correlation can essentially be further neglected.

For networking simulations we need a simulation environment that includes an implementation of the full 802.11p protocol, and at the same time is flexible enough to allow the new multi-link channel models with realistic auto- and crosscorrelation behavior. From this standpoint we use a combination of four connected frameworks, as detailed Figure 21, for the simulations:

- **OMNeT++** - Discrete Event Simulator, (<https://omnetpp.org>)
- **Veins** - Vehicles in Network Simulation, (<http://veins.car2x.org>)
- **Sumo** - Simulation of Urban Mobility, (<http://www.sumo.dlr.de>)
- **Plexe** - Platooning Extension for Veins, (<http://plexe.car2x.org>)

Veins include an implementation of the IEEE 802.11p Medium Access Control (MAC) layer and is also connected to the traffic simulator SUMO. Its connection to SUMO makes it attractive since it provides a means to perform realistic simulations of traffic flows on road stretches designed by the user or on road networks imported from OpenStreetMap, containing for example speed limits, buildings, and crossings. Plexe extends Veins by realistic simulations of platoons, i.e., by including several cooperative adaptive cruise control (CACC) algorithms and vehicle dynamics.

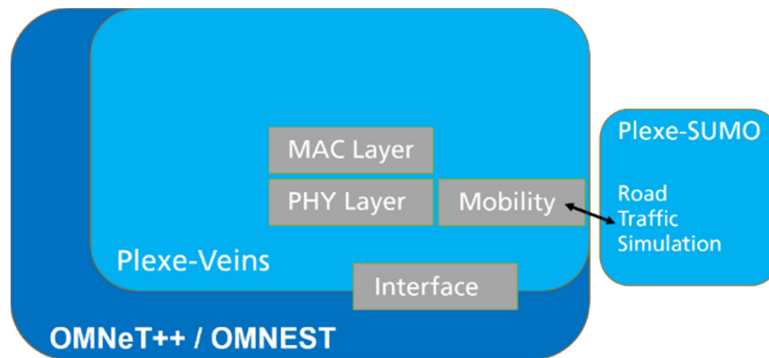

Figure 21. Simulation framework for network based simulations with an improved physical layer channel model.

A realistic channel model for LOS and OLOS scenarios have been implemented in the Plexe framework [5] based on the models in [3]. Dynamic model selection during simulation runtime has been implemented with the purpose of selecting the proper channel given the geometry. By doing so, we have implicitly modeled the cross-correlation between different V2V wireless communication links. Figure 22 shows an example of the new correlated large scale fading process (in blue) as compared to the conventional way of deterministic path loss and independent Nakagami-m fading (in red).

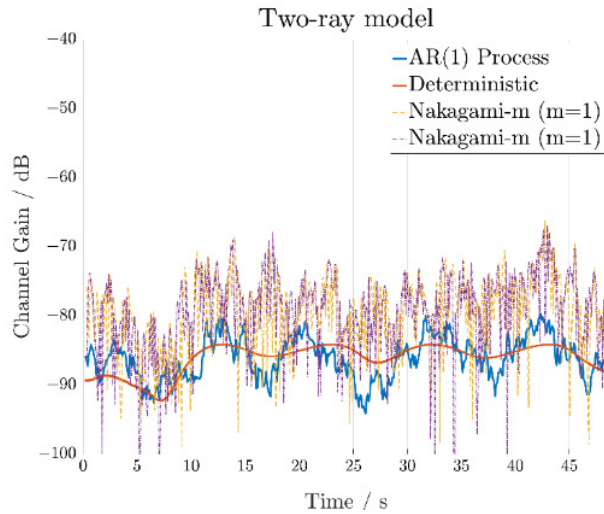

Figure 22. An example of simulated two path behavior. Conventional method in red (deterministic) with independent Nakagami- $m$  fading, and the implemented new model in blue.

### 5.2.4.2.3 Modelling of urban intersections

In a third measurement campaign we used six vehicles of different sizes to further characterize multilink behaviour. The main focus was urban intersections, though additional measurements were performed in the same highway environment as before.

Two cars and one truck formed a platoon (group) meeting another platoon in an intersection in the city of Göteborg. Signal strengths between all link combinations were measured with simultaneous GPS and video recordings. An overview of the scenario is presented in Figure 23, with the two main intersections. Further details of the scenario, channel characteristics and a model can be found in [1].

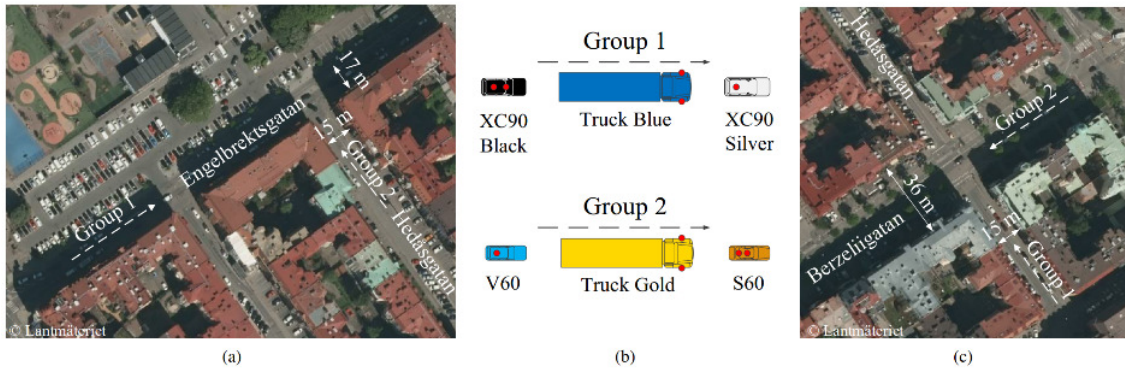

Figure 23. Measured urban intersections in Göteborg.



Figure 24 shows the 6 vehicles forming the two platoons, one truck and two cars in each.



Figure 24. Six vehicles forming the two platoons for the channel measurements.

Naturally, there will be shadowing and additional attenuation of the vehicles behind the trucks, whereas the trucks essentially experience no additional shadowing loss due to their elevated antennas. Figure 25 shows an example from a measurement scenario where the vehicles in group 2 receives packets from the first car in the other group. The vehicle in the back has 20-30 dB weaker signal strength, but is both shadowed by the truck and has a larger distance to the intersection.

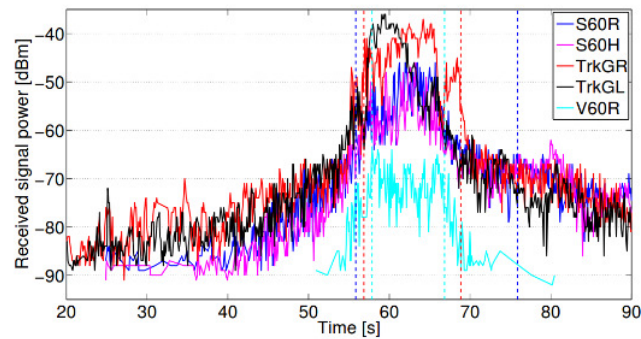

Figure 25. Example of measured signal strengths for three vehicles (group 2) approaching an intersection.

To characterize the influence of the other vehicles from an application perspective we have characterized the packet success ratio as a function of the so-called Manhattan distance between the vehicles. Figure 26 shows the packet success ratio between all vehicles when approaching the intersection. The two dashed lines in the figure indicate the packet success ratio for a *single* packet sent to give enough margin to avoid an accident for a manually driven car and an autonomous car in 50 km/h [1].



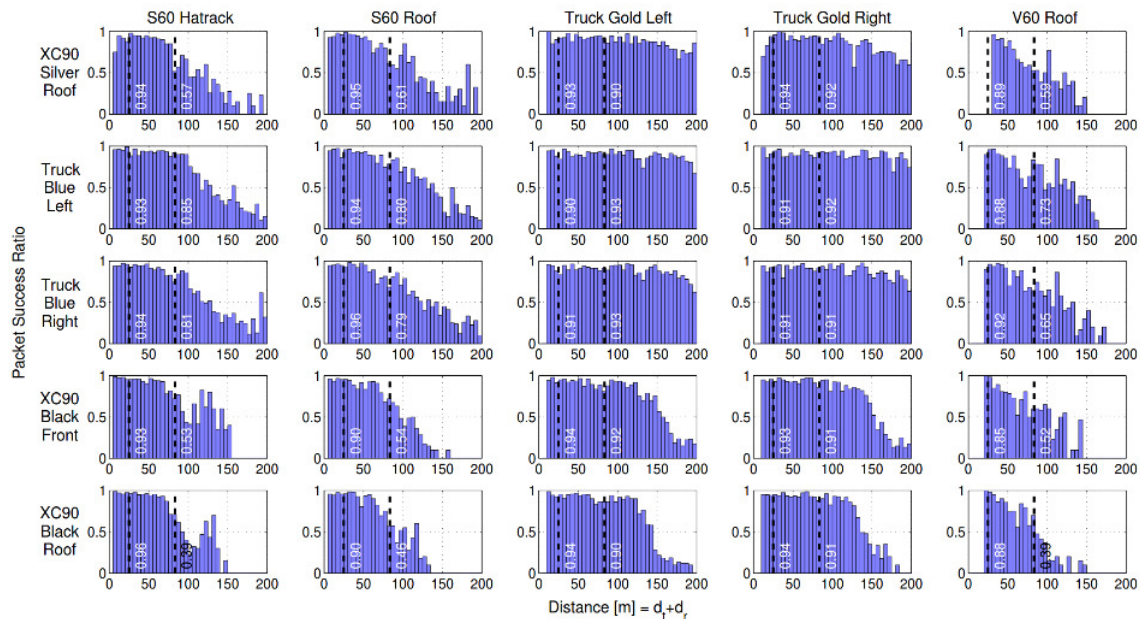

Figure 26. Measured packet success ratio for different vehicles approaching the intersection.

Based on the measurements we have come up with a new path loss model for vehicles in urban scenarios with shadowing from other vehicles, see Figure 27 for an overview of the geometry.

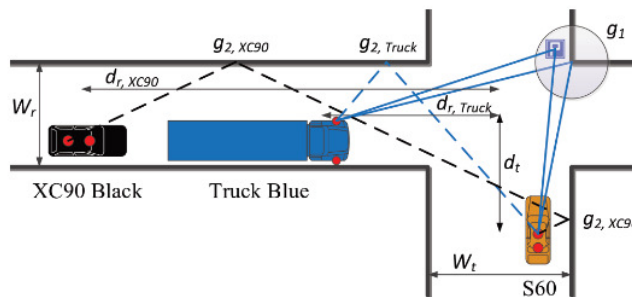

Figure 27. Channel model geometry for the path loss in an intersection with shadowing from other vehicles.

We have identified three main components contributing to the received power level: the LOS component (if existent), scattering from the intersection center, and scattering from surrounding walls. Depending on the physical geometry of the intersection and the location of the vehicles involved the contribution from the three components are adjusted accordingly [1].

The overall conclusion by our analysis of path loss, de-correlation distance, and multilink shadowing effects of V2 communication in urban environment, is that geometry based models shall be used for VANET simulations. By doing so, and using an appropriate channel gain model, the de-correlation distance can be close to what is experienced in reality and cross-correlation can be neglected. The latter will make the implementation of realistic models in VANET simulators much easier.

For the detailed intersection modelling we have also made a thorough analysis of scatterers, their contribution to the impulse response and behaviour in time based on ultrawideband measurements in Berlin by the Heinrich Hertz Institute [2]. Figure 28 shows an example of identified scatterers from those measurements in an intersection.

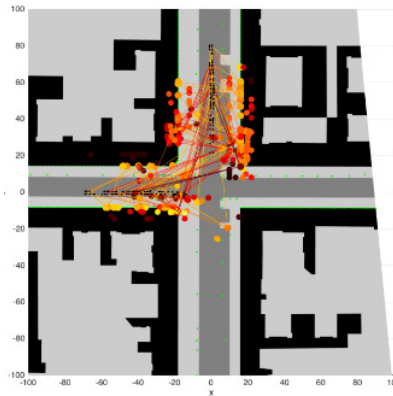

Figure 28. Identifies scatterers in an intersection in Berlin measured with a  $n$  ultrawideband channel sounder.

Based on the identified scatterers we have implemented a geometry based stochastic channel model for general intersections where scatterers are randomly placed according to the geometry defined, see Figure 29.

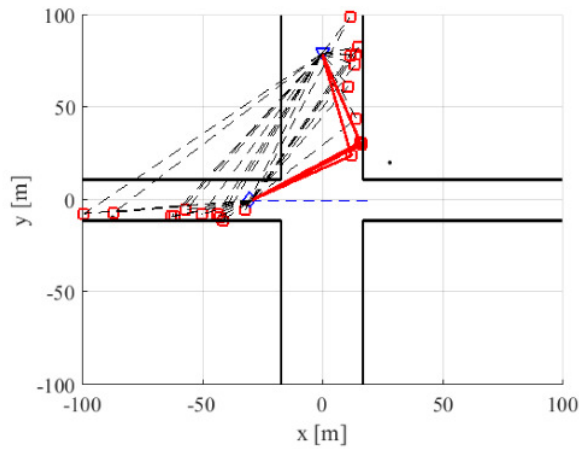

Figure 29. Scatterers in the simulation scenario.



Such a model implicitly can include different antenna patterns and can model a realistic time evolution of the channel as it is spatially consistent. Figure 30 shows an example of a generated impulse response from the scenario above.

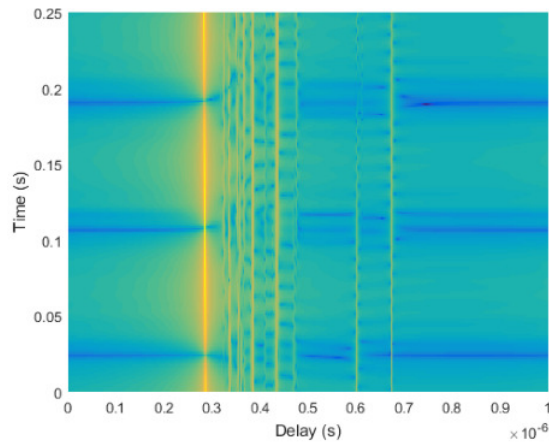

Figure 30. Example of a generated impulse response.

#### 5.2.4.2.4 Real time emulation of vehicular channels

The development in software radio technology has enabled real time implementation of channel emulators for vehicular communication. Since the vehicular channel is characterized by large delays and large Doppler spreads it is important to characterize modems in a straightforward manner with respect to those two parameters. In [9] we presented a stress test method for vehicular modems, where an artificial two-path channel is created with the second tap placed arbitrarily in the delay-Doppler plane. Figure 31 shows the setup with two test modems connected, and Figure 32 shows the structure of the two-path channel model.

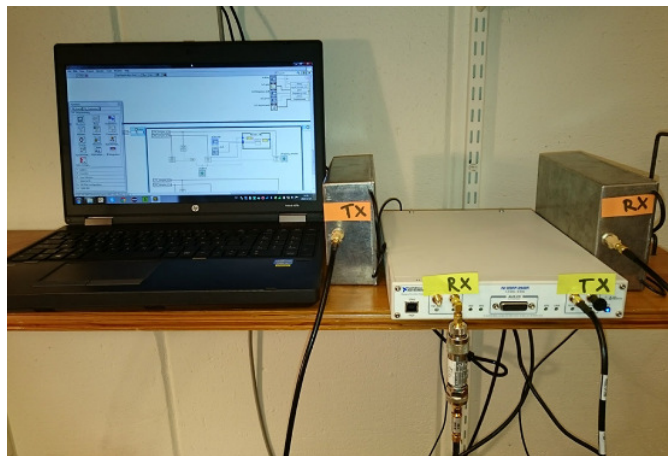

Figure 31. Software radio based setup for real time channel emulation.

This test focuses especially on one of the critical components in the modems, the channel estimator. Figure 32 shows a measurement result from a dedicated 802.11p chip set, as seen the communication works well up to a Doppler shift of 1300 Hz and a delay of 1.8  $\mu$ s, which should be sufficient for most of the vehicular scenarios though the performance could be improved.

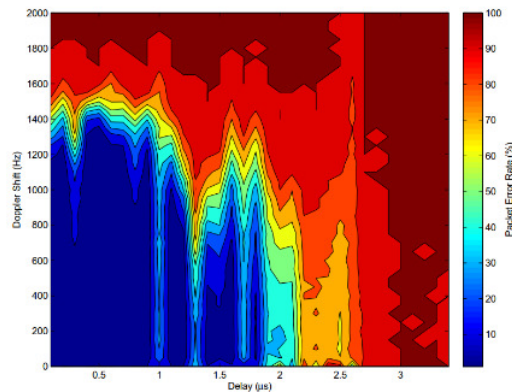

Figure 32. Stress test of a dedicated V2V modem, blue indicates the area where the modem is working properly.

We have also, together with Austrian Institute of Technology, investigated and characterized an implementation of a real time emulator where the model is directly generated from a geometrical description [14]. Current software radio technology allows for non-stationary channel models to be implemented, which should be very interesting for future development in the area.

#### 5.2.4.3 Conclusions & Future Research

This WP has focused on channel characterization and modelling for V2V communication. Based on the work we have presented one of the first multilink measurement campaigns, both with respect to highway scenarios as well as in urban intersections. We have made some important conclusions for simulations and created channel models including shadowing effects from other vehicles. Detailed results, analysis, models are presented in scientific journals and as conference contributions.

From a network perspective our recommendation is to use geometry based models. They are naturally spatially consistent, they can handle shadowing from other vehicles, and if the geometrical information is properly handled they also inherently can model cross-correlation between links from different vehicles. We have implemented the developed models in a network simulation framework, to enable further studies from an application perspective. We have also implemented a detailed simulation framework in MATLAB in order to do realistic link level simulations.

For the future we think it is important to continue with network level simulations, but with realistic behaviour when it comes to the physical layer. There are also many open topics when it comes to detailed channel characteristics in, e.g. intersections, to create reliable low latency communication and to enable highly accurate positioning. In the future the 802.11p standard will most likely include more antennas for the modems. Then the antenna correlation characteristics, that we have started to study here, will be even more important.

#### 5.2.4.4 WP1D References

- [1] M. G. Nilsson, C. Gustafson, T. Abbas, and F. Tufvesson: A Path Loss and Shadowing Model for Multilink Vehicle-to-Vehicle Channels in Urban Intersections, manuscript in preparation for IET Communications
- [2] C. Gustafson, K. Mahler, L. Pauser, D. Bolin, F. Tufvesson: A Geometry-based Stochastic channel model for V2V intersection scenarios based on high-resolution measurements, manuscript in preparation for IEEE Transactions on Vehicular Communication
- [3] M. Nilsson, C. Gustafson, T. Abbas, F. Tufvesson, "A Measurement Based Multilink Shadowing Model for V2V Network Simulations of Highway Scenarios", IEEE Transactions on Vehicular Technology, Vol.66, Issue 10, pp 8632 – 8643, Oct. 2017, DOI: 10.1109/TVT.2017.2709258



- [4] M. Nilsson, P. Hallbjörner, N. Arabäck, B. Bergqvist, T. Abbas, F. Tufvesson: Measurement Uncertainty, Channel Simulation, and Disturbance Characterization of an Over-the-Air Multi-Probe Setup for Cars at 5.9 GHz, *IEEE Transactions on Industrial Electronics*, Vol. 62, No. 12, pp. 7859-7869, 2015.
- [5] C. Gustafson, T. Abbas, D. Bolin, F. Tufvesson: Statistical Modeling and Estimation of Censored Pathloss Data, *IEEE Wireless Communications Letters*, Vol. 4, No. 5, 2015.
- [5] Christian Nelson, Nikita Lyamin, Alexey Vinel, Carl Gustafson, Fredrik Tufvesson, Lund University: Geometry Based Channel Models with Cross- And Autocorrelation for Vehicular Network Simulations, *IEEE Vehicular Technology Conference*, Porto, Portugal, May 2018, accepted
- [6] Dimitrios Vlastaras, Russ Whiton and Fredrik Tufvesson: A model for power contributions from diffraction around a truck in Vehicle-to-Vehicle communications, *15th International Conference on Intelligent Transport Systems (ITS) Telecommunications*, Warsaw, Poland, May 2017.
- [7] C. Gustafson, D. Bolin, F. Tufvesson: Modeling the Polarimetric mm-wave Propagation Channel using Censored Measurements, In *Proc. IEEE Globecom*, Washington D.C., Dec 2016.
- [8] M. Nilsson, D. Vlastaras, T. Abbas, B. Bergqvist, F. Tufvesson: On Multilink Shadowing Effects in Measured V2V Channels on Highway, *9th European Conference on Antennas and Propagation (EuCAP) 2015*, Lisbon, Portugal, 2015-04-12.
- [9] D. Vlastaras, S. Malkowsky, F. Tufvesson: Stress Test Of Vehicular Communication Transceivers Using Software Defined Radio, *81st Vehicular Technology Conference*, Glasgow, Scotland, 2015-05-11.
- [10] Strom, E.G.; Sjoberg, K.; Carlsson, J.; Majidzadeh, A.: Requirements and test methods for vehicular antenna systems supporting cooperative ITS applications, *Microwaves for Intelligent Mobility (ICMIM)*, 2015 IEEE MTT-S International Conference on, 2015, DOI: 10.1109/ICMIM.2015.7117939D.
- [11] Vlastaras, T. Abbas, M. Nilsson, R. Whiton, M. Olbäck, F. Tufvesson: Impact of a Truck as an Obstacle on Vehicle-to-Vehicle Communications in Rural and Highway Scenarios, *6th International Symposium on Wireless Vehicular Communications*, Vancouver, Canada, 2014-09-14.
- [12] C. Nelson et al, simulation code for multilink network simulations with realistic cross- and auto correlation in Plexe/Veins/Sumo/Omnet, lund-channels on GitHub, [Online]. Available: <https://github.com/chrinels/plexveins>, Dec. 2017.
- [13] C. Gustafson et al, MATLAB simulation code for realistic physical layer simulations of V2V communication in urban intersections, March 2018
- [14] M. Hofer, Z. Xu, D. Vlastaras, B. Schrenk, D. Löschenbrand, F. Tufvesson, T. Zemen, "Real-Time Implementation and Validation of a Geometry-Based Stochastic Channel Model", *COST IRACON*, Graz, Austria, September 2017.



## 5.2.5 WP1E: Verification of Wireless Technologies

### 5.2.5.1 Activities Performed

This WP was led by Volvo Car Corporation and has worked in parallel with WP1A, and the scope has primarily been on wireless system performance measurements.

The objective has been to identify and develop complete in-vehicle verification methods for the technologies developed in WP1A. During the development of various test methods, we have used the methodology DMAIC (Define, Measure, Analyze, Improve, Control) from Six Sigma to develop new test methods and improve them.

We strived to identify test methods which can be used as early as possible in our development of automotive wireless communication. The current usage of field trials with OTA measurements are time consuming, unreliable and expensive. The workpackage scoped on designing test methods which were designed to answer if the ideal function is achieved, meanwhile detect noise factors and potential error states. The figure below is described in WP1A.

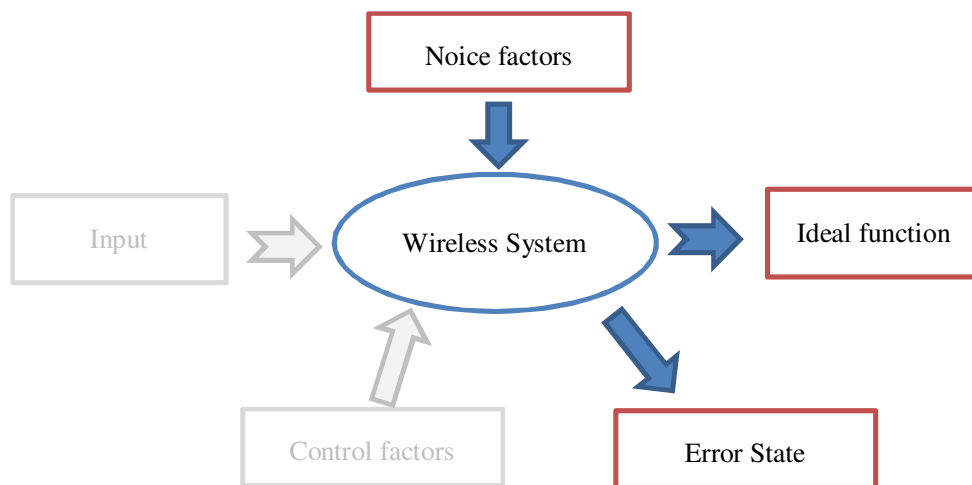

Figure 33 Overview of Wireless System with focus on Noise factors and Error State



#### 5.2.5.1.1 Testmethods evaluation

In WP1E, we investigated and identified Key Performance Indicators (KPI) for each wireless technology and performed studies to identify what tools are suitable for our wireless system. Beside KPI's, we considered quality and cost (time and equipment) for a specific test method to identify what we could use and what we could improve. We targeted to perform at minimum of one Measurement System Analysis (MSA) during the project, to identify and reduce variations in the test method.

In cases where we had applications distributed within the vehicle, we needed to identify a real end-to-end performance test method which could also address TCP/IP communication and routing performance.

#### 5.2.5.1.2 End-to-End performance testing

The eagerness to identify how to measure if the ideal function has been achieved triggered us to evaluate various test methods and tools on the market. We have been looking for a tool that could offer a suitable end-to-end performance testing, i.e. to identify the performance between the vehicle wireless equipment and nomadic devices. We identified the need to cover physical layer up to application layer for technologies such as Wi-Fi, LTE and Bluetooth.

Important KPI's are:

- Throughput
- Latency (One Way Delay)
- Jitter (latency variation)
- Packet loss
- RSRP & RSRQ (for LTE), RSSI & SNR (for WiFi)
- CPU load

Depending on which wireless technology that was used, there are additional KPI's (physical and datalink layer) that are important and considered in the test method.

#### 5.2.5.2 Results

The objective of developing complete in-vehicle verification methods has been successfully met, while also identifying challenges for future research project within the same area. Methods for system performance testing of wireless technologies such as Wi-Fi, Bluetooth and LTE (4G) have been developed and are today used as part of our verification process at Volvo Cars.

We have performed a set of experimental test setups at various areas to identify the pros and cons for each test method. Some of the test methods developed by FFI WCAE are now used in our current vehicle projects.



#### 5.2.5.2.1 Test methods for in-vehicle communication

We developed test method where we installed agents on the vehicle equipment and nomadic devices (smartphones, tablets). We were able to perform end-to-end performance testing covering Wi-Fi and LTE (4G). We could analyse the performance on nomadic devices standalone inside the vehicle and compare the results with FFI WCAE WP2A developed ECU.



*Figure 34 Invehicle setup with multiple smartphones*

#### 5.2.5.2.2 Experimental test setups at RISE (former SP)

OTA measurements have been performed at our project partner RISE's facility. We performed WLAN, Bluetooth and co-existence measurement with a various technologies inside the chamber.

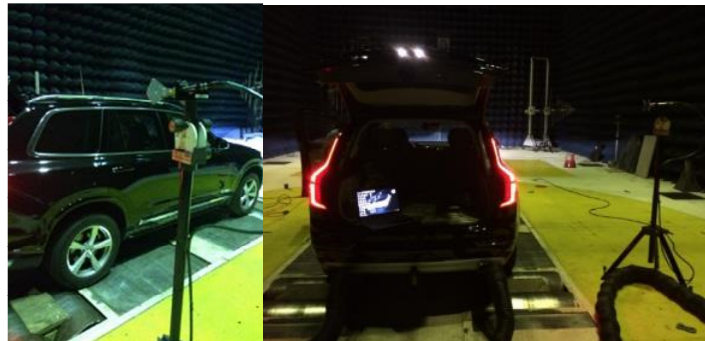

*Figure 35 OTA measurement at RISE*





### 5.2.5.2.3 Reverberation chamber test setup

Reverberation chambers are designed to reduce the time spend on OTA measurement. Within the FFI WCAE project, we evaluated the test method and results with our FFI WCAE wireless equipment (developed by WP2A) in a reverberation chambers. We identified that the usage of such chambers, provides a good indication on the performance of Wi-Fi and Bluetooth inside the vehicle.

### 5.2.5.2.4 End-to-end testing measurement campaign

We have performed end-to-end testing based on our FFI WCAE developed test methods on testdrives around Göteborg and through Europe to evaluate the LTE network performance. We compared performance between smartphones and the FFI WCAE developed ECU (WP2A). In the measurement campaigns, we measured the performance to our own cloud to identify the throughput under specific conditions. Additionally, we made detailed analysis on the One Way Delay (OWD), packet loss, jitter and compared cellular KPI's (RSRP, RSRQ etc) for different scenarios.

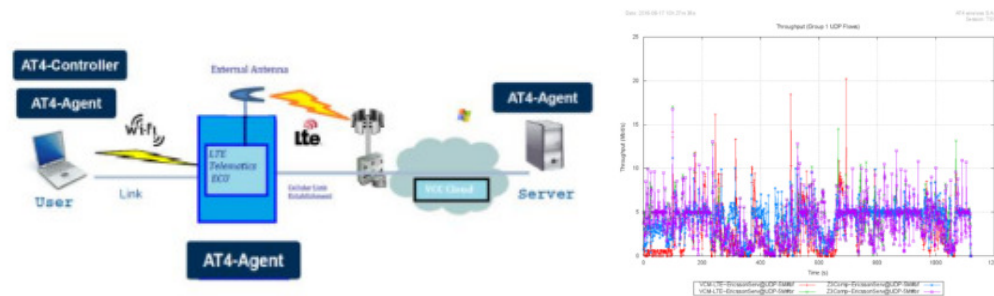

Figure 36 Overview of testtool developed by DEKRA

### 5.2.5.3 Conclusions & Future Research

The use of different types of test methods during the vehicle development cycle is key to securing quality and sufficient performance of the wireless communication. It's clear that simulations are an important way of assessing the system in early stages of the development, while full system testing is necessary in the last industrialization phase to secure that the "ideal function" is achieved. We have learned that the test object size (vehicle) and moving to multiple antenna systems are complicating factors when setting up OTA tests. Additional research projects will continue focusing on simulations and testmethods.

### 5.2.5.4 WP1E references

- [1] System DVM LTE
- [2] System DVM WLAN\_V2X\_ITS\_G5\_WAVE\_v1.0.2
- [3] System DVM Attribute WiFi Internal Performance
- [4] System DVM Attribute WiFi External Performance
- [5] DVM WLAN PL and DL Layer
- [6] DVM WLAN Security
- [7] DVM WLAN Software
- [8] Review DVM WLAN
- [9] DVM LTE PL and DL Layer
- [10] DVM WLAN C2X ITS G5 WAVE PL and DL Layer
- [11] DVM BLE Review PHY



[12] DVM BLE Review Security

[13] DVM BLE Review Host



## 5.2.6 WP2A: Retrofit solution for V2X services based on 802.11p

### 5.2.6.1 Activities Performed

The objective of this work package was to present a solution for V2X communication using radio 5.9 GHz for the European standard ITS-G5 (IEEE 802.11p). When the project started there were no retrofit solution available on the market. Activities within the work package should speed up the number of C-ITS equipped vehicles to enable presentation of road traffic safety messages and road traffic efficiency applications.

Within this work package Kapsch has been developing and produced a V2X ECU Evaluation kit (EVK-3300) and necessary firmware to support further research and development within this area.

In parallel Kapsch has been working on software to communicate between the V2X ECU's and applications that implements the ETSI Use Cases for Stationary Vehicle Warning, Emergency Electronic Break lights and Traffic Light Optimal Speed Advisory (GLOSA).

The EVK with our applications has been used in several tests and demos during this project.

### 5.2.6.2 Results

#### 5.2.6.2.1 V2X ECU Evaluation kit

The communication between vehicles and infrastructure will be done by radio over 5.9 GHz in this project. Since there was a quite new area of business the manufacturers of radio chip was in an early stage of developing hardware components. The first step within the project was therefore to evaluate the available radio modules on the market. For this purpose Kapsch has developed an evaluation kit "EVK" with the possibility to exchange daughter boards with different radio modules.



Figure 37 KAPSCH EVK-3300 V2X Evaluation Kit



The EVK-3300 is a generic platform for V2X-communication. It is designed and mounted with either of three different daughter boards with radio modules from different radio manufacturers for evaluation of performance:

- Renesas
- NXP
- Murata/Qualcomm

The Murata/Qualcomm version was also evaluated in the first run with discrete radio solutions from Qualcomm before modules were available. We had to develop drivers for the Qualcomm chip internally since no commercial software was available.

An overview block diagram of the hardware architecture in the EVK-3300 is given below. Functionality encapsulated by a dotted box is realized on corresponding add-on boards. All antennas are external, so the antenna symbols are only included for completeness. Brief descriptions of the respective blocks are given in the coming subsections.

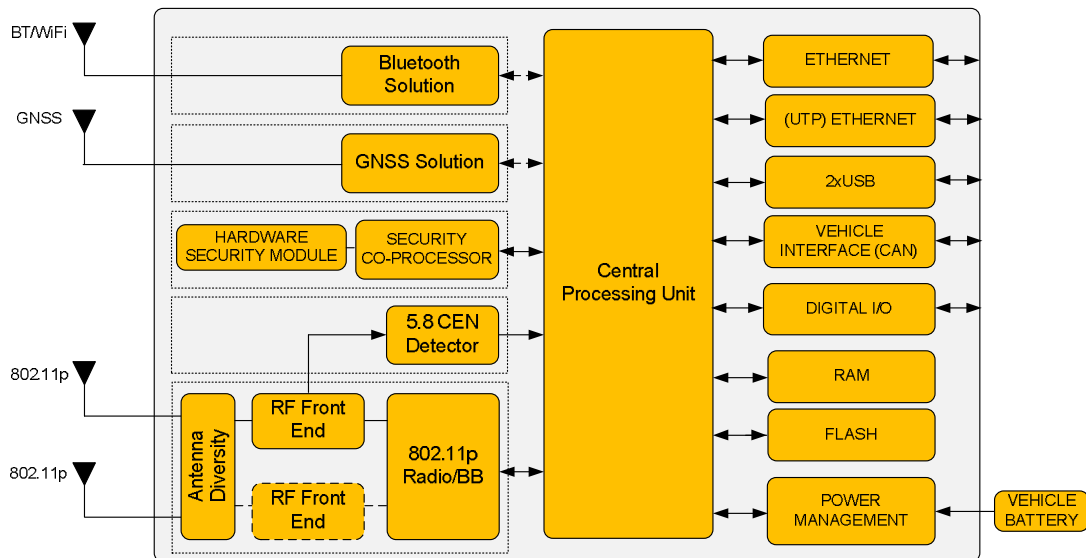

Figure 38 Hardware block diagram of the EVK-3300. The dotted boxes represent add-on boards.

#### 5.2.6.2.1.1 Power Management

The power management block is comprised of voltage regulators, filters and protection in accordance with ISO 7637, which allows for connection directly to the vehicle battery. The two system voltages, 5V and 3.3V, are converted from the vehicle voltage using switched and linear regulators in a manner that optimizes the overall power consumption.

The EVK-3300 features a simple power management scheme in order to avoid draining of the battery when the vehicle is parked. The transition between the two power states „active“ and „deep sleep“ are based on:

- Ignition status sensing
- CAN activity/inactivity
- On/Off button of the device

The allowed input voltage range is 8 - 36V. The current consumption at 24 V input is typically 125 mA in full operation and less than 100 uA in deep sleep mode.



#### 5.2.6.2.1.2 RAM and FLASH Memory

The RAM and FLASH memories used are of type SDRAM and NOR FLASH, which are qualified in accordance with AEC-Q100. At least 30% of the memory space is available for future functional growth.

#### 5.2.6.2.1.3 Digital I/O

The EVK-3300 provides four digital input signals that can be used e.g. for sensing odometer pulses and driving direction indication.

Furthermore, two digital outputs are provided that can be controlled by on board applications.

#### 5.2.6.2.1.4 Vehicle Interface (CAN)

The EVK-3300 features two High Speed CAN 2.0B interfaces for vehicle bus integration and/or point-to-point communication with a separate ECU. The interface support bitrates up to 1 Mbit/s on both CAN interfaces.

#### 5.2.6.2.1.5 USB

The EVK-3300 can also be interfaced via a USB interface, supporting data rates up to 480 Mbps.

The device can act as either a USB host or a USB device.

The EVK-3300 also comprises a USB debug interface, running a virtual COM port.

#### 5.2.6.2.1.6 Ethernet

The EVK-3300 features both a standard Ethernet and Ethernet via unshielded twisted pair, for either high speed vehicle bus integration, or as a point-to-point communication link with a separate ECU.

#### 5.2.6.2.1.7 Central Processing Unit

The CPU in the EVK-3300 is based on an ARM926 core running at 450 MHz.

The central processing unit handles all vital platform functionality such as:

- Operating System (openWRT based on Linux kernel 3.10.12)
- 802.11p radio driver
- GNSS receiver driver
- ITS G5 Protocol Stack
- ITS Facilities
- Vehicle interfaces
- Device Management and Diagnostics
- Power Management

#### 5.2.6.2.1.8 Bluetooth

The EVK-3300 utilizes a Bluetooth module with support for the Serial Port Profile (SPP) for fast and secure transparent serial data transmissions. The module supports the Bluetooth 2.1+EDR standard for enhanced data rates (Bluetooth 3.0 prepared via firmware upgrade).

#### 5.2.6.2.1.9 GNSS

The GNSS module features support for concurrent multi-constellation GNSS systems.

The following GNSS systems are supported:

- GPS
- Glonass
- Galileo



The module further supports several satellite based augmentation systems, including EGNOS for Europe and WAAS for North America.

The positional update rate of the GNSS module is 10 Hz.

The GNSS Module features phantom power supply (3.3V, max 25mA) of an external LNA and antenna detection monitoring, by means of DC load measurement.

The evaluation kit was mounted with either of two different GNSS modules; Telit and uBlocks.

Analysis and tests have been done to improve the solution for positioning. As a result digital wheeltick is integrated to enhance dead reckoning functionality.

#### 5.2.6.2.1.10 Security Co-Processor and Hardware Security Module

This functionality was planned but not implemented in the EVK 3300. Studies during this project has helped understanding this field for implementation in coming generations.

#### 5.2.6.2.1.11 5.8 CEN DSRC Detector

The 5.8 CEN DSRC detector is comprised of 5.8 GHz AM detector circuitry and logic that analyses the incoming frames and verifies that the signals are 5.8 CEN DSRC frames. Upon reception of a correct frame, a notification is sent to the CPU for further actions.

#### 5.2.6.2.1.12 802.11p Radio and Baseband

The 802.11p radio/baseband module handles the access layer of the communication stack. It is designed specifically for 5.9 GHz communication in a vehicular environment, where fast fading channels may be present.

Since the 802.11p Radio and Baseband technology is one of the key components in a C-ITS product, Kapsch is using a multi-vendor approach, where the radio solutions from different vendors are compatible to run on the platform.

The EVK-3300 features radio solutions that can support either concurrent dual channel operation or combined antenna diversity.

#### 5.2.6.2.1.13 RF Frontend

The RF frontend includes Power Amplifier, Low Noise Amplifier and a switch that controls whether the antenna is coupled to the transmit or receive path, respectively. The switch is controlled by the 802.11p baseband/radio.

The RF Frontend further comprises a directional coupler that couples a small portion of the incoming RF signal to the 5.8 CEN DSRC detection circuitry.

#### 5.2.6.2.1.14 Antenna Diversity

The EVK-3300 platform supports different 802.11p radio solutions, with different features regarding antenna diversity and/or MIMO.

The currently available add-on modules of the EVK-3300 comprise radios supporting both a simple form of antenna switched diversity but also variants supporting combined signal diversity where the signals from two separate receive chains are combined for maximum diversity gain. The latter also supports transmit diversity, according to the cyclic delay principle, where the signal to one of the antennas are delayed slightly in time to avoid destructive interference.

#### 5.2.6.2.1.15 Human Machine Interface

The EVK-3300 comprises a rudimentary HMI in order to give immediate feedback of the current overall operating status of the platform and the add-on boards and to manually power up/down the device.



#### 5.2.6.2.1.16 Functional Architecture

A functional block diagram of the provided functionality and interfaces is given below.

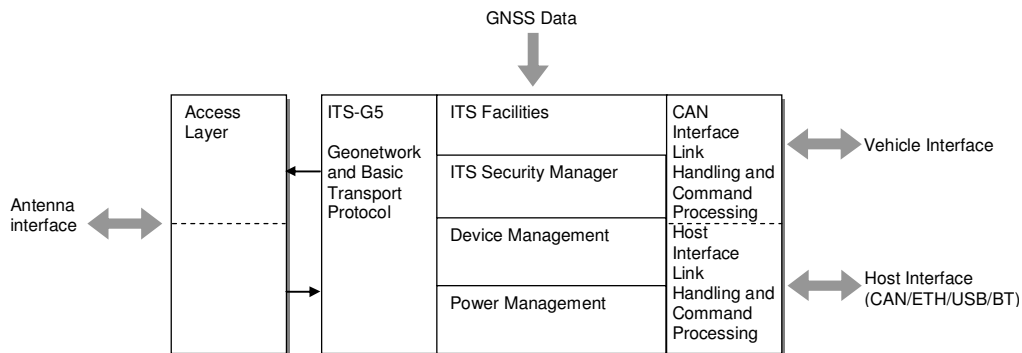

Figure 39: Block Diagram of the provided functionality in the EVK-3300

#### 5.2.6.2.1.17 Access Layer

The access layer comprises the 802.11p radio and baseband processing, including also link and medium access control such as CSMA/CA, transmit power control and transmit queues. The access layer also includes specific functionality like Channel Busy Ratio estimation and reporting needed for the Decentralized Congestion Control mechanism.

#### 5.2.6.2.1.18 Geonetwork and Basic Transport Protocol

The Geonetwork and Basic Transport layer of the ITS G5 protocol stack handles the message porting, geographical addressing and forwarding strategies as specified in the ETSI ITS G5 standards. The protocol supports both single-hop and multi-hop communication.

This functional block further comprises a location table with the geographical position of all the ITS Stations within communication range that is utilized when routing messages using the different forwarding algorithms. The location table also includes information about their estimation of the channel busy ratio, should it be needed by the DCC mechanism.

The following geonetworking features are supported by the EVK-3300:



Table 1: Geonetworking features supported in the EVK-3300

Feature	Description
<b>Geoadressing Schemes</b>	
<b>Beacon</b>	<b>Beaconing is used to periodically advertise the position of an ITS Station.</b>
<b>GeoUnicast</b>	<b>Point to point message via multi-hop unicast messages.</b>
<b>GeoAnycast</b>	<b>From one unit to at least one unit inside the Geographic area.</b>
<b>GeoBroadcast</b>	<b>From one unit to all units inside the Geographic area.</b>
<b>Topologically-Scoped Broadcast</b>	<b>Single-hop Broadcast or Multi-hop Broadcast</b>
<b>Location Service</b>	<b>The location service is used if an ITS-Station needs to determine the position of another ITS-Station.</b>
<b>Forwarding Mechanisms</b>	
<b>GeoUnicast Greedy Forwarding</b>	<b>Supported</b>
<b>GeoUnicast ContentionBased</b>	<b>Under development</b>
<b>GeoBroadcast Simple</b>	<b>Supported</b>
<b>GeoBroadcast ContentionBased</b>	<b>Under development</b>





Characteristic	Value
<b>Overall Characteristics</b>	
Dimensions (LxBxH)	120 x 170 x 35 mm
Weight	550 grams
Main Connector	Tyco MQS 26W
RF Connectors	FAKRA
Operating Temperature	-40°C to +85°C
<b>Power Supply</b>	
Supply Voltage	8-36 VDC
Current Consumption (24V)	Typically 125 mA Sleep mode: < 100 uA.
<b>Wired Interfaces</b>	
Ethernet	RJ-45 connector
UTP Ethernet	BroadR-Reach (MQS Connector)
USB	Host/Slave (Micro A/B connector) Debug (Micro A/B connector)
HS CAN 2.0B	Two (MQS Connector)
Digital Inputs	Four (MQS connector)
Digital Outputs	Two (MQS connector)
<b>Add-on Boards</b>	
KRM-QCA-1: 1x1 802.11p Radio	



<b>Sensitivity AWGN conditions</b>	<b>-95 dBm @ 6 Mbps</b>
<b>Maximum Output Power</b>	<b>+23 dBm<sup>1</sup></b>
<b>Diversity Support</b>	<b>Antenna switched diversity</b>
<b>KRM-QCA-2: 2x2 802.11p Radio</b>	
<b>Sensitivity AWGN conditions</b>	<b>-93 dBm @ 6Mbps</b>
<b>Maximum Output Power</b>	<b>+23 dBm<sup>1</sup></b>
<b>Diversity Support</b>	<b>Maximum Ratio Combining</b>
<b>KPM-STM-1: GNSS Module</b>	
<b>GNSS Systems</b>	<b>GPS, Glonass, Galileo</b>
<b>SBAS Support</b>	<b>WAAS, EGNOS, MSAS</b>
<b>Update Rate</b>	<b>10 Hz</b>
<b>Time-to-First-Fix</b>	<b>&lt; 35 s in good receiving conditions</b>
<b>Position Accuracy (CEP50)</b>	<b>1.5 m</b>
<b>CoB-OBS-419: Bluetooth Module</b>	
<b>Bluetooth version</b>	<b>v2.1 +EDR</b>
<b>Supported Profiles</b>	<b>Serial Port Profile (SPP)</b>
<b>Output Power</b>	<b>Class 1, +4 dBm</b>
<b>Receive Sensitivity</b>	<b>-84 dBm</b>
<b>Android Support</b>	<b>Yes</b>
<b>iPhone Support</b>	<b>No</b>



<b>KSM-NXP-1: Security Processing (Not yet available)</b>	
<b>Signing</b>	<b>Up to 20 Messages per second</b>
<b>Verification</b>	<b>Up to 400 messages per second</b>
<b>Type Approvals</b>	
The EVK-3300 has not been formally type approved.	

---

<sup>1</sup> The output power may be subject to reduction pending compliance with the spectrum mask over the operating temperature range.



#### 5.2.6.2.1.19 Evaluation kit generation 2

In the end of this project Kapsch started to design a new version of the evaluation kit in order to support V2X pilots. Input from evaluations and pilots running the last years are considered in the new design.



*Figure 40: Evaluation Kit Generation 2*

This product will be scalable and the basis for customized serial development. The design is work in progress targeting the following specifications and options.



<b>V2X Module</b>	
<b>Dimensioned to run Stack, verification and dispatching over CAN/Ethernet.</b> <b>CPU, GNSS, SAM, Radio</b> <b>Optional GNSS antenna board</b> <b>Micro SD</b>	<b>I/O</b> <b>Automotive Ethernet, CAN FD.</b> <b>Dual 5,9 GHz antenna and single GNSS</b> <b>Private Ethernet over USB to CPU module</b>
<b>V2X Application module</b>	
<b>V2X module and CPU module dimensioned to run applications</b> <b>WIFI, Bluetooth, USB hub, micro SD</b> <b>Optional LTE Board</b>	<b>Additional I/O</b> <b>Ethernet, USB C</b> <b>Private Ethernet over USB to V2X module</b> <b>Internal HDMI</b>

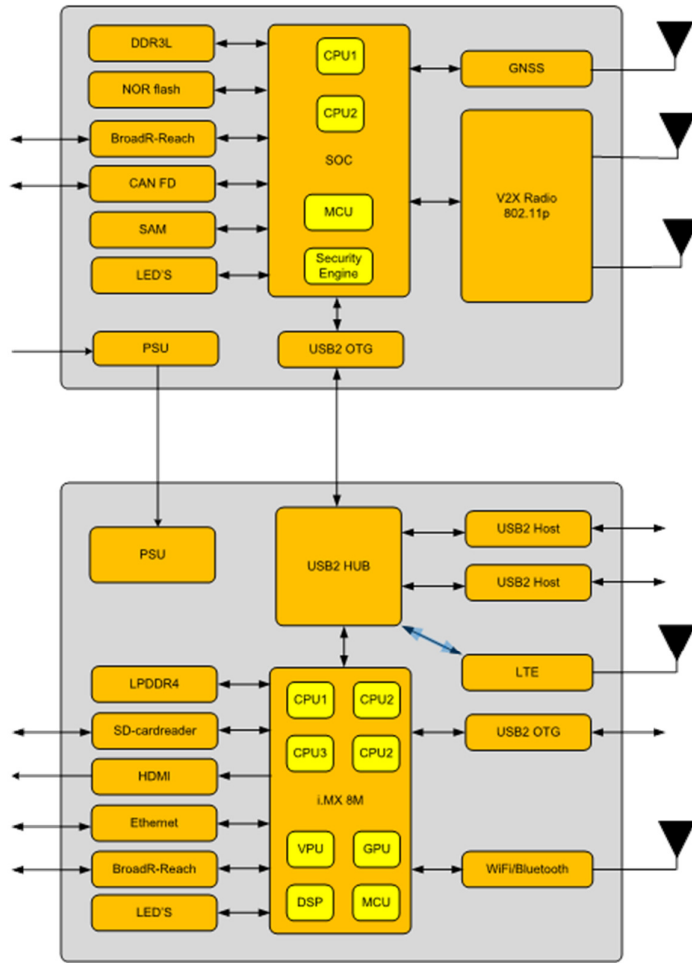

Figure 41: Hardware block diagram of the EVK generation 2.

5.2.6.2.2 Stack

Kapsch has continuously participated in the standardization within ETSI and implemented an ITS-G5 communication stack. This implementation has evolved with current standardization during the project and has been the basis for the demonstration use cases.

A first version of security with functionality to sign and verify messages is now being implemented in the ITS G5 Protocol Stack.

Kapsch has evaluated the latest proposal for an AUTOSAR V2X stack, but not yet implemented it.



### 5.2.6.2.3 Implementation of Use Cases STV, EEBL and GLOSA

ETSI has defined use cases for C-ITS. In this project we have chosen to implement three of these applications in order to design and learn the architecture needed:

Stationary Vehicle Warning (STV)	Road traffic safety
Emergency Electronic Break lights (EEBL)	
Traffic Light Optimal Speed Advisory (GLOSA)	Road traffic efficiency

The basis of the V2X Communication platform is implemented and verified within this project with these applications realized by SPaT and MAP messages.

HMI are developed in WP 2C.

The applications have been demonstrated within WCAE.

#### 5.2.6.2.3.1 Demo Setup

The use cases were realized in a retrofit (installed after production of the vehicle) proposal in a Volvo truck as well as a linefit (installed during production) proposal in a Volvo XC90. Furthermore, for GLOSA demonstration, VGTT instrumented a couple of traffic light installations on Hjalmar Brantingsgatan in Gothenburg.

The Demo setup encompasses Volvo trucks and XC90s equipped with V2X radios as well as intersections with traffic light controllers equipped with V2X radios. The use cases EEBL and STV are based on V2V communication, i.e. the vehicles send out messages when stationary (and Hazard lights activated) and when emergency braking.

These messages are then picked up by the other vehicles and a notification is presented via the HMI to the driver.

The GLOSA use case is based on V2I communication, the infrastructure (traffic light controller) is transmitting MAP and SPAT messages informing nearby vehicles of the geometry of the intersection and the phases of the traffic signals. The calculated speed recommendation for a “green wave” is then presented to the driver.

The presentation is done on the instrument cluster of the trucks and/or on a standalone tablet HMI in the XC90s.

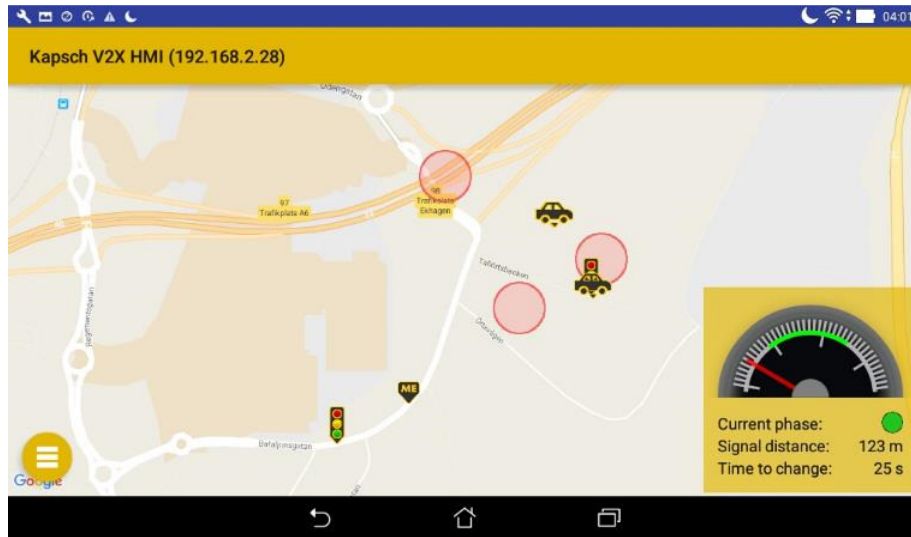

Figure 42: Kapsch V2X HMI

5.2.6.2.3.2 Demo architecture in Truck

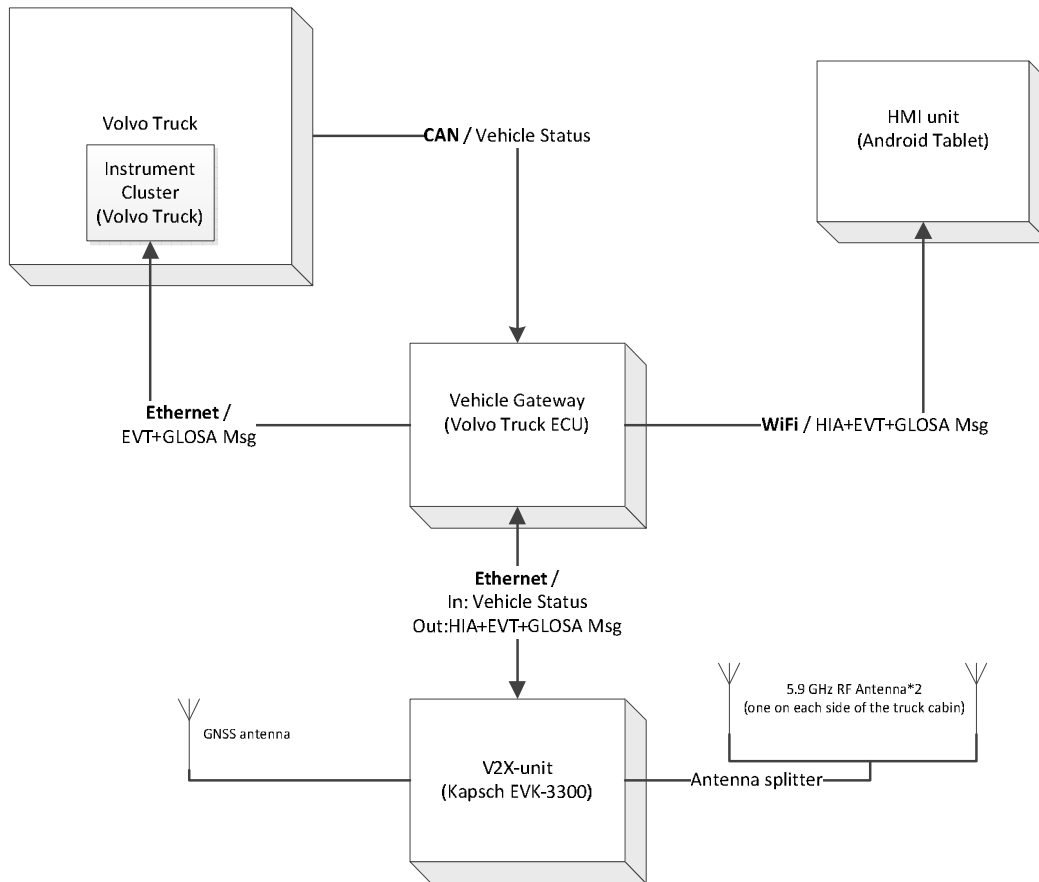

Figure 43: Overview of Hardware architecture for Demo case in Volvo truck





For the truck integration a Vehicle Gateway is introduced by VGTT with the main purpose of routing information from the truck to the V2X-unit as well as routing information from the V2X-unit to the instrument cluster (and secondary HMI unit).

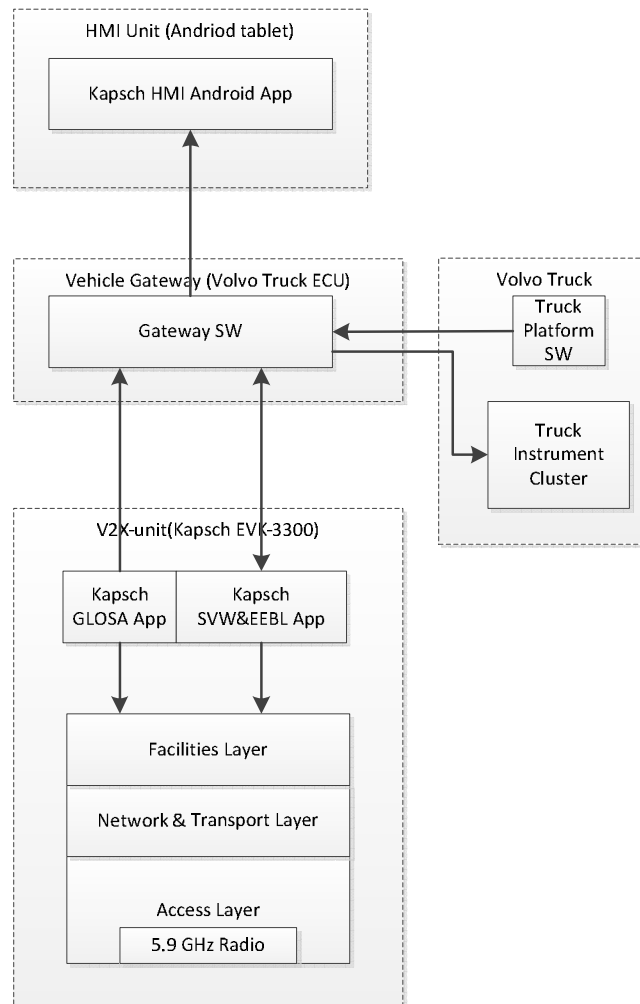

Figure 44 Overview of Software architecture for Demo case in Volvo truck, dashed boxes represent processing nodes.



### 5.2.6.2.3.3 Demo architecture in XC90

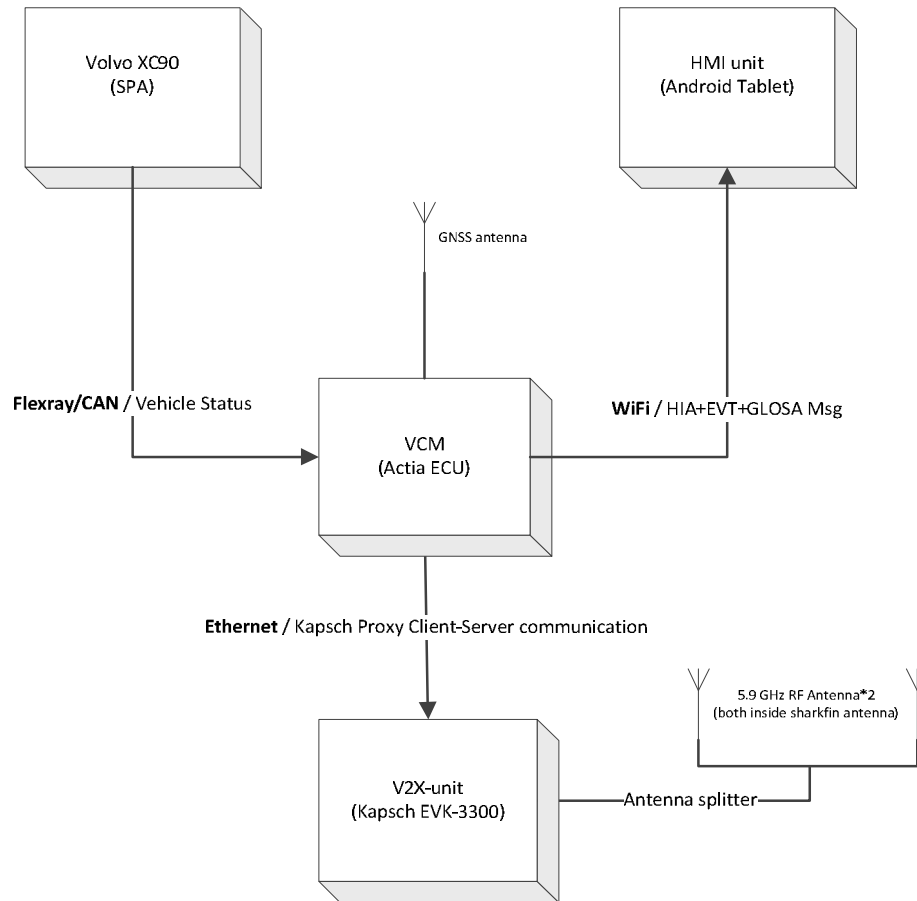

Figure 45: Overview of Hardware architecture for Demo case in Volvo XC90.

For the XC90 integration Actia's VCM manages integration to the vehicle and HMI unit. The V2X applications are deployed in the VCM and access the stack and radio deployed in the V2X unit via a proxy solution.

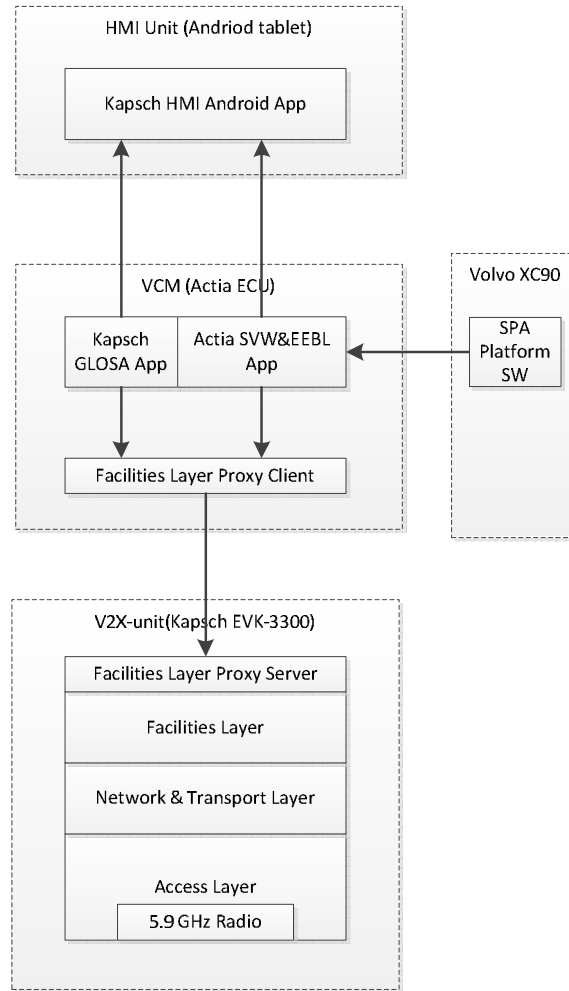

Figure 46: Overview of Software architecture for Demo case in Volvo XC90, dashed boxes represent processing nodes.

### 5.2.6.3 Conclusions & Future Research

The development of this comprehensive solution that includes both requirements on the application level, communications protocols and hardware support has helped all participating parties to progress in this field.



## 5.2.7 WP2B: Integrated Solution for Future Vehicles

### 5.2.7.1 Activities Performed

#### 5.2.7.1.1 Introduction

The WP was led by ACTIA in cooperation with Kapsch, VCC and Volvo AB

The following main tasks were performed [1-5]:

- Integration of LTE/4G connectivity (Hardware and Software)
- Integration of Wi-Fi IEEE 802.11 ac connectivity (Hardware and Software)
- Integration of V2X Facility Layer Proxy Client and V2X applications (EEBL, SVW and EEBL)
- Integration of AT4 Client (test software for wireless communication)
- Study concept for colocation of antennas and transceivers “Smart Antenna Module”
- Demonstration and test of the WP2B Node

#### 5.2.7.1.2 WP2B Node description

WP2B Node is an integrated connectivity node supporting both wireless and wired communication.

WP2B Node Wireless communication consists of:

- LTE Category 3, 2x2 MIMO in DL direction, max theoretical data rate: Downlink 100Mbps, Uplink 50Mbps
- IEEE 802.11 b/g/n/ac, one spatial streams, 2,4&5GHz operation, max theoretical data rate: 433Mbps
- 802.11p, External V2X Radio connected via Ethernet to the WP2B Node (for V2X radio details see WP2A)

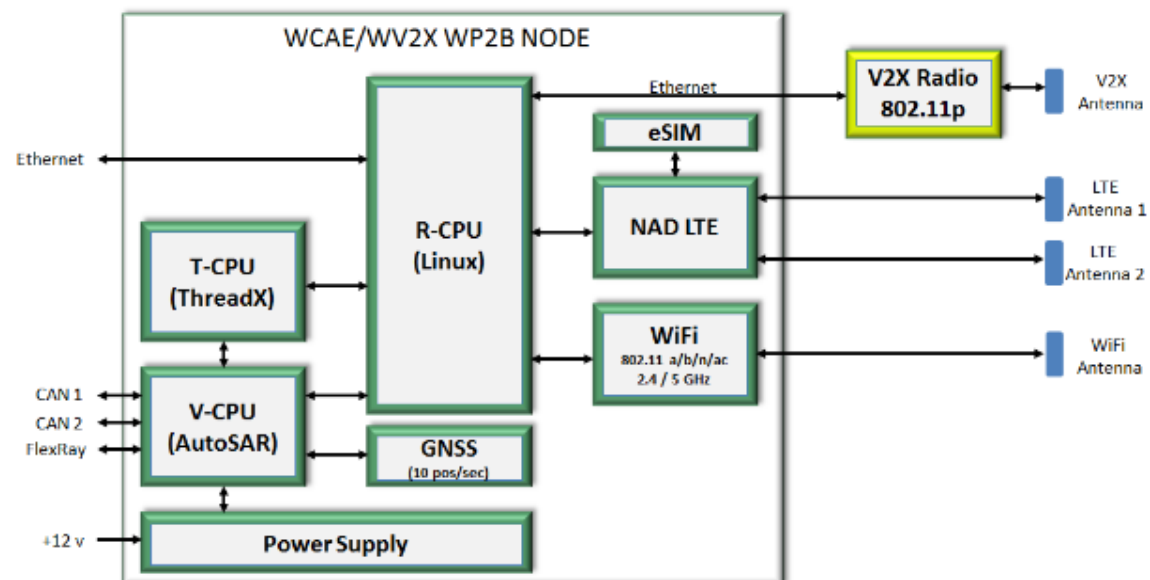

Figure 47: WP2B Node High level system architecture. Router-CPU is the central component hosting the interfaces and applications for wireless communication (Wi-Fi, LTE and V2X).

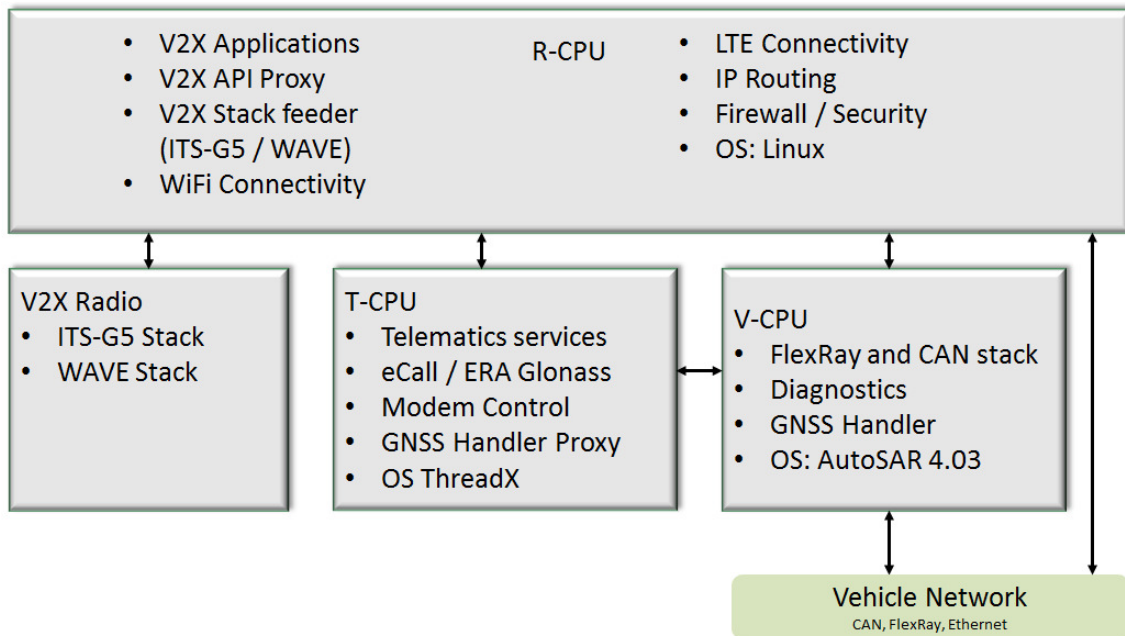

Figure 48: WP2B Function partitioning.

#### 5.2.7.1.3 Smart Antenna Module

One task for WP2B was to study concept for collocation of antennas and transceivers in a “Smart Antenna Module” (SAM)

The collocation have several advantages, some examples:

- Easier vehicle integration (fewer cables from roof to body)
- RF losses caused by long coax cables is reduced
- Lower system cost for the OEM (easier vehicle integration, no long coaxial cables)

The main challenge for a smart antenna module located in the roof area of the vehicle is the exposure to high temperature. In order to evaluate concepts for heat dissipation a SAM prototype and still air chamber have been developed.

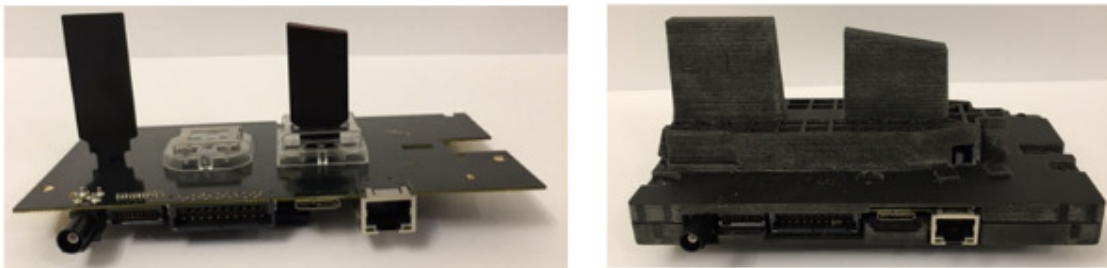

Figure 49: Smart Antenna Module

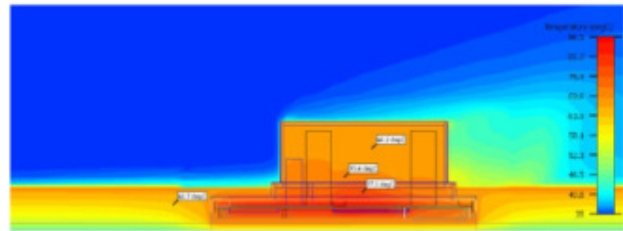

Figure 50: Still air chamber

**5.2.7.2 Results**

5.2.7.2.1 Prototypes

A prototype of the WP2B Node was developed using the system architecture in Figure 1, and function partition in Figure 2.

A Smart Antenna Module prototype has also been developed, this prototype has mainly been used for thermal evaluations (see Figure 3 and Figure 4).

5.2.7.2.2 WCAE RF Measurement Campaign 2016 week 24

The focus for WCAE WP2B during the measurement campaign was to evaluate WP2B Node LTE performance (Vehicle embedded system) compared to a smartphone LTE performance in a vehicle environment.

The extended time series is illustrated in Figure 5 and Figure 6. It can be a bit difficult to draw any conclusion by just looking at the plots.

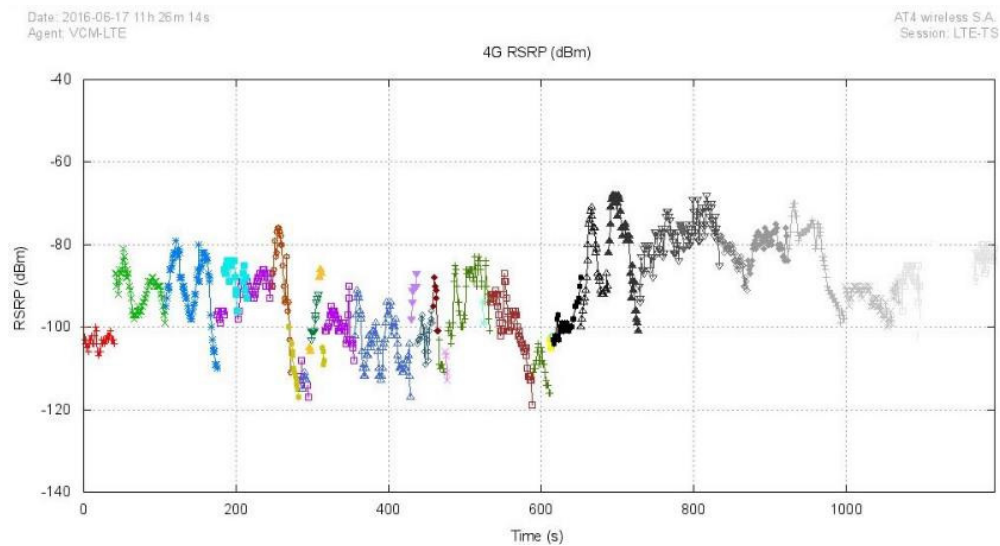

Figure 51: VCM RSRP



Date: 2016-06-17 11h 26m 14s  
Agent: Xperia Z5

AT4 wireless S.A.  
Session: LTE-TS

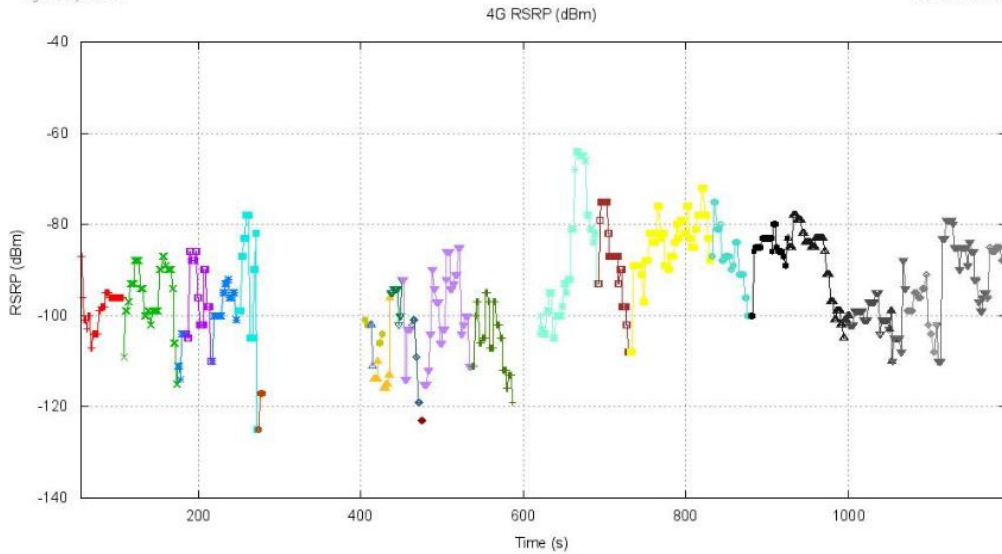

Figure 52: Z5 RSRP

However when comparing the average signal strength the test results from measurements show that VCM High has quite better signal power than other phones used in the test. The RSRP of several measurements is illustrated in Table 2 below. The VCM is better in four out of five measurements.

Meas.ID	2016-06-17 09h 51m 46s			2016-06-17 11h 04m 46s			2016-06-17 11h 26m 14s			2016-06-17 09h 52m 53s			2016-06-17 11h 06m 32s		
DUT	Z3 Comp	VCM	Diff	Z3 Comp	VCM	Diff	Z3 Comp	VCM	Diff	Xperia Z5	VCM	Diff	Xperia Z5	VCM	Diff
RSRP (dBm)	-88,30	-81,56	6,75	-83,76	-80,10	3,66	-81,20	-82,39	-1,20	-89,00	-83,14	5,86	-83,22	-78,06	5,16

Table 2: Average Received Signal Strength Indicator for VCM and two smartphones. The VCM is at most 6.75 dB more sensitive.

In conclusion, in this LTE test scenario, VCM LTE is the device with best user experience. In general, VCM LTE has better signal reception and shows better values in packet loss and One Way Delay. VCM is in most cases more sensitive at receiving LTE signals compared to tested smartphones. This will have a positive impact on the user experience when using the VCM as an internet source, since sensitivity is correlated to the throughput. Some analysis uncertainty is added by the fact that the data sets had a few gaps where no samples were available. For details, see reference [6].

### 5.2.7.3 WP2B Wi-Fi AP Measurements

WP2B have performed Wi-Fi AP Conducted measurement on the WP2B Node in a controlled environment. By performing a conducted RF-measurement, the influence of surrounding Wi-Fi networks can be minimized in the performance measurement. The results are to be used as a reference for comparison with over-the-air performance measurements performed by VCC.

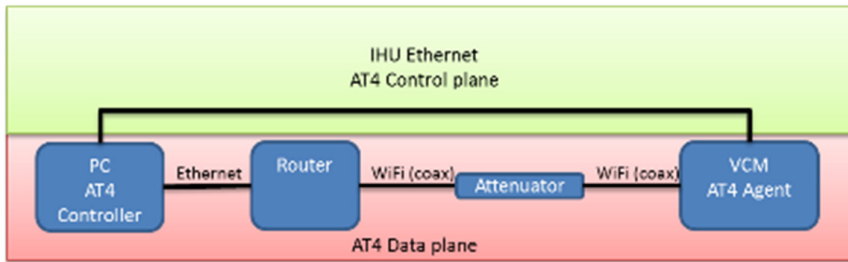

Figure 53: Measurement setup overview drawing. The VCM is acting as Wi-Fi AP and the router is configured in Bridge mode. PC, router and VCM are all on the same subnet.

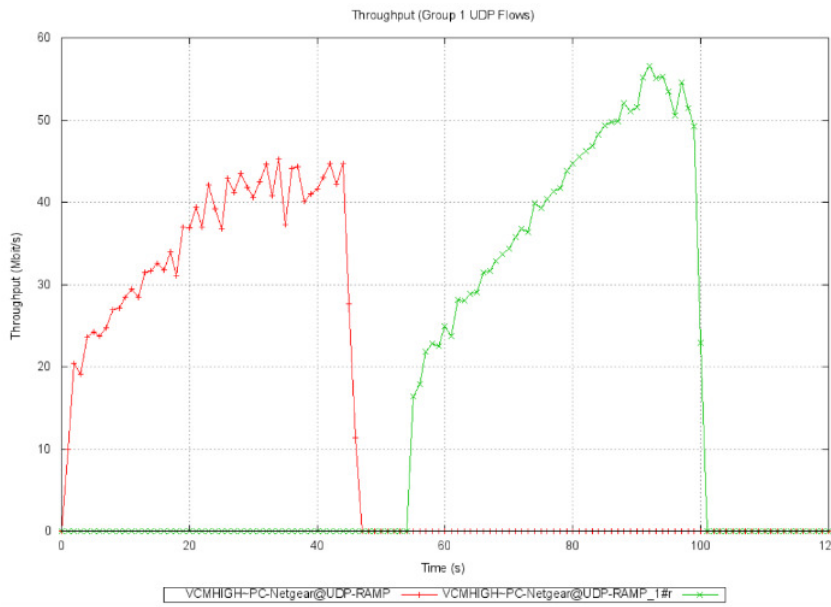

Figure 54: UDP Ramp up with 20 MHz BW @ 2.4 GHz with 59dB attenuation. The throughput is lesser when the VCM is transmitting (in the red left curve) and greater when receiving (in the green right curve).



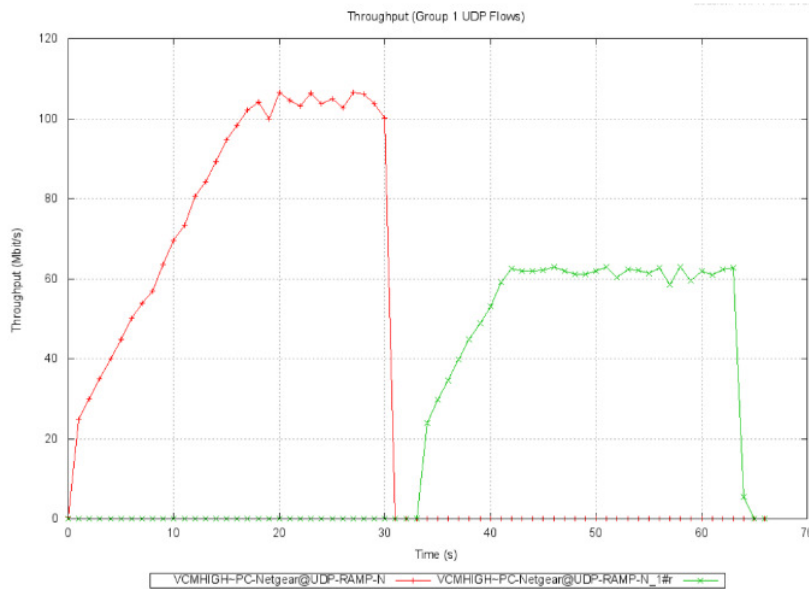

Figure 55: UDP Ramp up with 40 MHz BW @ 5.2 GHz with 46 dB attenuation. The throughput is greater when the VCM is transmitting (in the red left curve) and lesser when receiving (in the green right curve).

As seen in figures Figure 54 and Figure 55 the max throughput goes from 55Mbit/s to 105 Mbit/s when increasing from 20 to 40 MHz channel bandwidth.

For the 2.4 GHz 20 MHz bandwidth tests, the VCM (WP2B Node) is best at receiving. This changes when going to 5.4 GHz and 40 and 80 MHz bandwidth. It is not possible to observe any significant increase in throughput when the bandwidth is increased from 40 to 80 MHz. These two different behaviours indicates that there are two kinds of bottlenecks observed: one is the maximum physical rate at a 20 MHz bandwidth channel, and one is an internal bottleneck when the bandwidth is increased. For details see reference [5].

#### 5.2.7.4 WCAE Demonstration Days:

WP2B V2X, LTE and Wi-Fi was successfully demonstrated during the WCAE Demonstration Days 2016 September 28-29.

The following V2X use cases were demonstrated:

- Emergency Electronic Brake Light (EEBL)
- Stationary Vehicle Warning (SVW)
- Green Light Optimal Speed Advisor (GLOSA)

Wi-Fi was demonstrated via V2X HMI tablet connected to the WP2B Node via Wi-Fi.

V2X HMI data was also transmitted via LTE to the conference room.

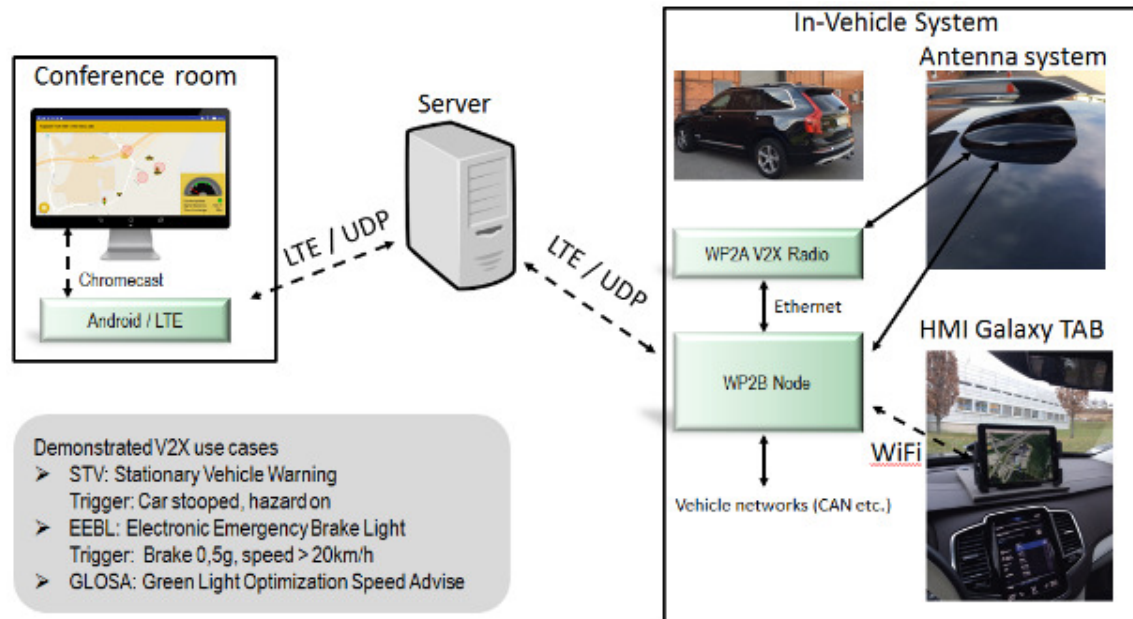

Figure 56: WP2B Demonstration days XC90 Demo setup.

### 5.2.7.5 Conclusions & Future Research

The performance evaluations show the WP2B Node system architecture is able to deliver good performance to meet the needs of the next upcoming vehicle designs. The V2X evaluation is possible to include in the ECU, but a separate radio ECU is recommended. Further, the architecture is capable to be applied in a smart antenna module, where this WP has produced a method for investigating high temperature effects on such an ECU. As the smart antenna is a strong path to further continue to optimize future vehicle designs, further research is needed on how to address the increasing need of performance in the connectivity and V2X ECU, which is mounted in one of the most extreme positions of the vehicle.

### 5.2.7.6 WP2B References

- [1] WCAE\_WV2X WP2B System Architecture Description 2.1
- [2] WCAE WP2B Hardware Design Description (HDD) rev 1\_0
- [3] WCAE WP2B SWDD V1\_0
- [4] WCAE WP2B Verification specification rev 1\_0
- [5] wifi-conducted-20161109
- [6] LTE evaluation embedded vs mobile v1\_0



## 5.2.8 WP2C: User interface for WCAE-enabled services (HMI)

### 5.2.8.1 Activities Performed

#### 5.2.8.1.1 WP Structure

WP2C consisted mainly of the following parts and activities:

- State of the Art analysis
  - Looking at the current situation in C-ITS development in the automotive industry. Daimlers, BMWs and Hondas solutions were looked at with focus on HMI solutions. In addition, the Drive C2X EU-project was briefly investigated for inspiration.
- Understanding the needs by formulating research questions and writing use cases.
  - Clear research questions was written to understand the work package goals, limitations and challenges. These RQs became the focus of WP2Cs development.
- Building a holistically designed HMI prototype including selected C-ITS features.
  - To apply learnings from SoA analysis and understand how to best design the HMI for our selected C-ITS features, a Hi-Fi HMI prototype was developed and installed in the truck.
- Performing clinics
  - To determine if the progress was going in the right direction, two clinics were performed. One simulator clinic and one in the Hi-Fi prototype installed in the truck.

### 5.2.8.2 Research Questions

In order to have a clear goal of the work package some research questions was formulated at the beginning of WP2C. Some of these questions were answered through a literature study while some were tested in a simulator/truck equipped with C-ITS functionality (or simulated functionality that was triggered manually). These research questions were used in the design process that resulted in the final HMI design of WCAE WP2C.

1. **How to coach with minimum distraction to the driver?**
  - a. Is coaching with multiple modalities better than only visual, from a distraction point of view?
  - b. Can we decide which modality/modalities are best during certain situations?
    - Heavy traffic
    - City
    - Highway
    - Road
    - Off-Road
  - c. Can radar signals be used to further detail the DIS functionality? (Get info from DACU, calculate in QT)
2. **Should the information towards the driver be prioritized and coordinated?**
  - a. Is it useful for the driver to notice that there is more than one warning at the time?
  - b. Is there a threshold distance/time in which the information is not useful for the driver (divided per application)?
  - c. Is there any condition when more than one warning should be shown at the same time?
  - d. Is there any C-ITS application information that should not be shown during certain traffic situations (even if there is no other warning to be shown)?
  - e. Is it necessary to have differences in priorities between different scenarios (city, highway, country road)?
  - f. Is the use of multiple-stage warning reducing the number of hard-breakings (useful for load vehicles) compared to a one-stage warning?



- g. Is it useful to select one-stage warnings for repetitive warnings? If so, for what applications? (GLOSA?)
- h. Does the use of a multiple-stage warning help the user to understand the situation or does it complicate the understanding of the situation?
- 3. **How to present cooperative information and make sure that the driver understands why a certain action is asked for.**
  - a. Does the use of a multi-modal warning help the user to understand better the cooperative information?
  - b. Can the user understand a warning better in a specific modality (visual, haptics, sound)?
  - c. Is the input given to the driver guessable/understandable? (Icons, sounds, haptics etc.)?
- 4. **How to design one holistic HMI solution for all cooperative C-ITS features?**

### 5.2.8.3 Use Cases

The subsections below describe the C-ITS use cases (applications) that were used in this WP.

#### 5.2.8.3.1 Emergency Electric Brake Light (EEBL)

The truck driver is looking for the spot where he needs to leave the load. He sees it as he just passed it. He brakes hard because otherwise he will need to drive for at least 5min to go back to the same spot. All the cars in the queue receive the EEBL signal as soon the truck driver is braking hard, even though they do not see the truck. They were able to stop in time without having an accident.

#### 5.2.8.3.2 Stationary Vehicle Warning (SVW)

The truck driver is driving in the countryside. On the right side of the road, a car has stopped up ahead. The stationary car is occupying part of their lane.

The truck informs its driver that there is a stationary vehicle up ahead. The truck can reduce speed in time to pass the stationary vehicle safely.

#### 5.2.8.3.3 Green Light Optimization Speed Advisory (GLOSA)

The car has no navigation route started. The driver turns on the left indicator. One block from the next left turn there is a traffic light turning red. The driver is informed the range of speed he should hold to pass the traffic light in its green phase. In addition, the time to red is shown so the driver can adjust to traffic is any. The driver follows the advice and arrives to the traffic light when it is green. He does not need to stop the car thanks to the given information.

### 5.2.8.4 Literature

Ho, C. and Spence, C. (2008). The multisensory driver. Implications for Ergonomic Car Interface Design.

Ho, C., Spence, C. and Tan H.Z. (2005). Warning signal go multisensory. Proceedings of HCI International 2005 2284, 1-10.

Lerner, N., Robinson, E., Singer, J., Jenness, J., Huey, R., Baldwin, C., & Fitch, G. (2014). Human factors for connected vehicles: Effective warning interface research findings. (Report No. DOT HS 812 068). Washington, DC: National Highway Traffic Safety Administration.

Spence, C., Nicholls, M.E.R. and Driver, J. (2001). The cost of expecting events in the wrong sensory modality. Perception and Psychophysics, 63 (2), 330-336.

Spence, C. and Read, L. (2003). Speech Shadowing while Driving: On the Difficulty of Splitting Attention between Eye and Ear. Psychological Science, Vol. 14, No. 3, 251-256.



Van Erp, J.B.F. & Van Veen, H.A.H.C. (2004). Vibrotactile in-vehicle navigation systems. Transportation Research, Part F 7, 247-256.

### 5.2.8.5 Results

WP2C resulted in an HMI design for the C-ITS features Emergency electric brake light, stationary vehicle warning and green light optimization speed advisory. Since a holistic umbrella design was done, several more theoretical C-ITS features were also included.

#### 5.2.8.5.1 C-ITS prototype

A holistic design was thought of throughout the process. Therefore a zoomed out approach was active when considering features. The following features were included in the HMI design, even though not all of them were actually implemented.



Figure 57: HMI design features

#### 5.2.8.5.2 Clinics

Several small and ad hoc clinics were performed with the initial desktop prototype. These consisted of specific design questions during the design process and were performed in an iterative fashion to get feedback on specific question marks.

A bigger HMI design clinic was performed in the truck to evaluate the design. It was done to solve design issues at hand, for instance acceptance of a certain HMI decision or if the graphics was understandable.

The clinic was a combined clinic with an internal Volvo project, which made it possible to test some of the implemented C-ITS functionality in the HMI (GLOSA, EEBL, SVW and roadwork warning) with a head up-display present in the vehicle. First, six engineers with truck driver license tested the design. One week later, 11 professional truck drivers made the same run. The results were then compared.

The reception of both the new functions as well as the new technology was overwhelmingly positive. Even the older drivers who were a bit reluctant to begin with found that most of the functions would help them during their daily work. Especially GLOSA was received with great joy of all drivers, and the acceptance of that function was immediate.

Finally, a clinic to determine the order of prioritization was performed. It was necessary to understand what to prioritize and when since several warnings can come at the same time. Since a holistic design approach was used, many C-ITS warnings were introduced at the same time and the need for prioritization was high.

#### 5.2.8.5.3 HMI Prototype Implementation

##### 5.2.8.5.3.1 Infotainment Layout

The infotainment layout used for this project consisted of three separate devices. The devices are a Head-Up Display (HUD), an instrument cluster (IC) and a secondary information display (SID).



### 5.2.8.5.3.2 HUD

The use of a HUD was key for the success of this project. The placement of the HUD is in front of the driver at the lower part of the windshield, above the dashboard. The HUD projection enables the user to look at the information displayed without having to change the focus in depth as the HUD displays its information seemingly ten meters in front of the truck (this range varies between HUDs). In effect, the driver reduces the time with eyes off road, as the information is located closer to the normal visual focus point of the driver.

### 5.2.8.5.3.3 HUD areas

The HUD was divided in two areas with different urgency levels.

#### Speed related zone

In this area all the information relative to the speed is displayed. This information includes C-ACC, GLOSA and speed limit advice. This area is always displayed while the truck is turned on.

#### Notification zone

In the notification area, all notifications are displayed. It include warnings or navigation information. The area can fit up to two notifications. The usage of the area depends of the received information and in a regular driving experience could be empty for some periods of time. If two notifications are displayed, the one with highest urgency will occupy more space in the notification area. This will enable the user to focus on the one with highest urgency in situations with high workload.

2 different zones with different level on urgency

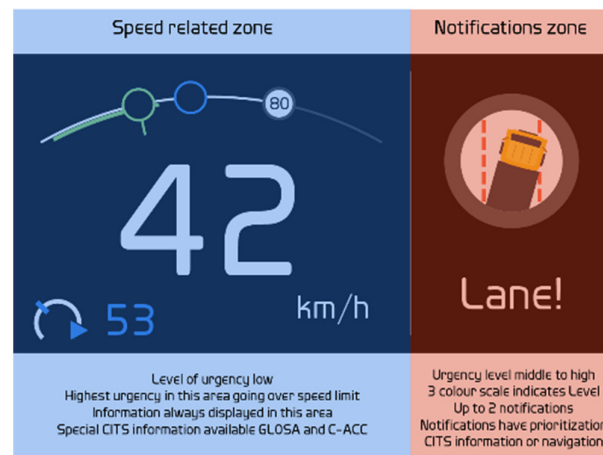

Figure 58: HUD Areas

### 5.2.8.5.3.4 Cluster

The cluster gives extra spatial information to the driver compared to the HUD. Once the user has been notified of a certain warning/notification, and if location information is necessary, the user can check the cluster. The user will have a map/lane indication to check where the warning is placed or how to avoid it. The map pops up in the notification zone of the cluster.

### 5.2.8.5.3.5 Cluster areas

Most of the clusters space is occupied by truck indications. Due to this reason, all V2X communication information was placed inside the speedometer, which is centred in the cluster area.

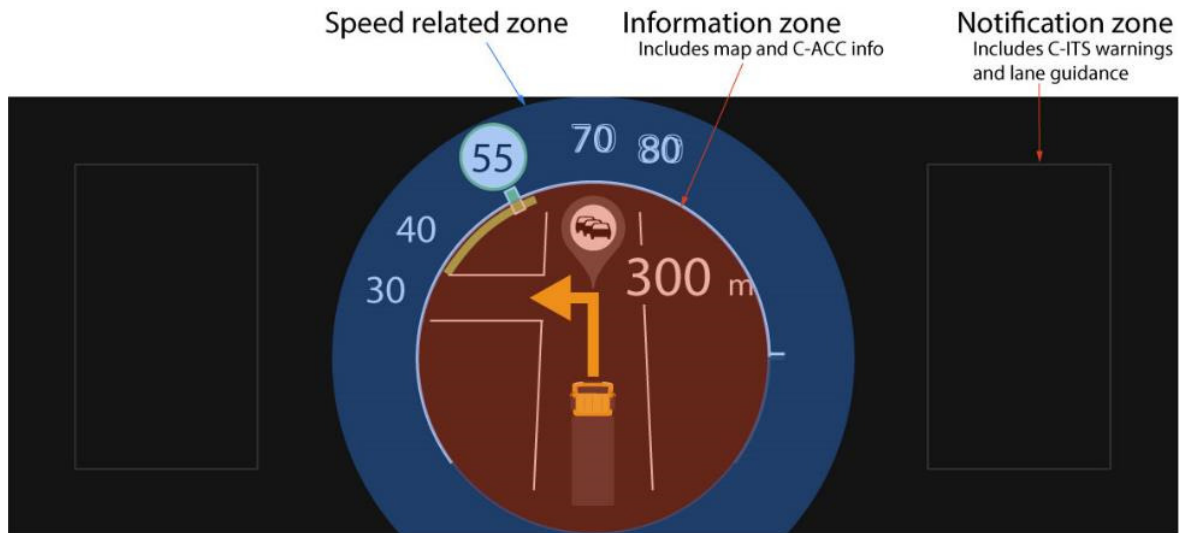

Figure 59: Cluster Areas

Same as in the HUD, the information in the cluster was separated in a speed advice area and a notification area. In the cluster, there is also an additional information area. Everything related to the speed indication (GLOSA, speed limit, C-ACC set speed etc) was placed in the speedometer arc - speed related zone. The information zone includes the following: C-ACC information, V2X target detected and map popping up. The notification zone shows the same information as the HUD except that only one piece of information at a time is shown due to screen height restrictions.

#### 5.2.8.5.3.6 SID

The information displayed in SID should only be used for planning when the user is not driving or to give a bigger overview while driving for easier manual reroute planning. The placement of the device is not good from a distraction point of view.

The SID consists of a navigation map with warnings and navigation recommendation. If the user selects a warning, a pop-up with extra information will appear. However, this was not implemented due to lack of time.

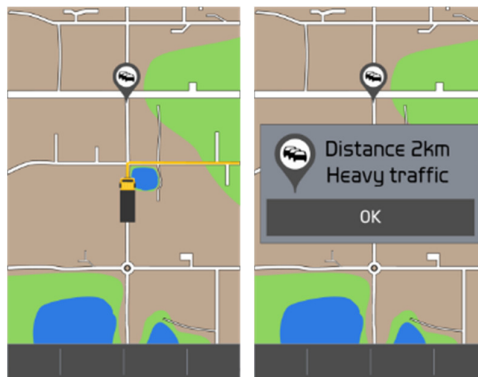

Figure 60: SID



#### 5.2.8.5.4 Priorities

A huge challenge of this project was how to provide the user with information of the environment while so many things are going on in the surroundings. It is understood that a prioritization was needed when one of more warnings was send at a time.

With the prioritized list produced during the project and the variables at hand, the following algorithm was determined.

$$P = S^{1.35} \times T$$

P = Priority value (the higher the prioritized).

S = Safety critical value

T = Time critical value

The variables were turned into numbers as follows:

Values	Safety critical	Time critical
High	4	4
Medium	3	3
Low	2	2
None	1	1

Figure 61: Priorities





The table below shows the results of the DIS priority clinic concerning the introduced C-ITS features. If two warnings should occur at the same time, the one with the highest priority will be shown first.

Indications	Safety Critical	Time Critical	Regulatory (Mandatory)	Driving Relevance	Real-time	Priority
GLOSA	None	Medium	No	Yes	No 1 3	3 P13
EEBL	High	High	No	Yes	No 4 4	25,9920767 P1
Stationary vehicle	Low	Medium	No	Yes	No 2 3	7,64736376 P8
Emergency vehicle	Medium	Medium	No	Yes	No 3 3	13,2201063 P4
Low bridge	Medium	Medium	No	Yes	No 3 3	13,2201063 P4
Slow vehicle	Low	Medium	No	Yes	No 2 3	7,64736376 P8
Road work	Low	Low	No	Yes	No 2 2	5,09824251 P10
Green corridor	None	Medium	No	Yes	No 1 3	3 P13
FCW	High	High	No	Yes	No 4 4	25,9920767 P1
Park search	None	Low	No	Yes	No 1 2	2 P15
Lane change	Medium	High	No	Yes	No 3 4	17,6268085 P3

Table 3: DIS priority clinic

### 5.2.8.6 Conclusions & Future Research

WP2C created a multimodal HMI design for C-ITS features. Not only were the required three features designed for, but a whole range of C-ITS features. This enabled us to think broad and made a big impact on the final design.

One key decision we made was to do a holistic umbrella design. This was a success for the project since future projects can build on the results of this project. Due to the umbrella design, it eases the introduction of new features even though they were not a part of this project.

Future research should consist of further integrating the prioritization list into the vehicles complete set of features as well as performing a user test over a long period of time.

To challenge the scope further, a complete user needs analysis should be performed before a follow up project is initialized to see what the users want, see how they want to use it and identify problems they experience in their daily work that can be solved with C-ITS features.



## 5.2.9 WP3A: Verification of System in Vehicle

### 5.2.9.1 Activities Performed

The purpose of this work package (WP3A) was to verify day-one use cases (V2X use cases, or applications, according to ETSI IT-G5 and IEEE 802.11p) installed in vehicles based on the outcome of WP2A, WP2B, and WP2C.

WP2A developed a prototype retrofit solution for V2X. In order to speed up the deployment of V2X services or add functionality to the existing population of vehicles, retrofit units are an option for vehicles that are delivered without embedded V2X functionality.

WP2B developed a prototype ECU, the “WCAE Node”, with mobile network capabilities, in-vehicle network (CAN, Flexray and Ethernet) interfaces, and an interface to the V2X prototype developed in WP2A.

WP2C developed a prototype HMI solution for Volvo Trucks with the purpose to properly visualize, evaluate and experiment with the V2X services made available in the project.

The V2X day one use cases (applications) studied in the WCAE project were:

- Emergency Electronic Brake Light (EEBL)
- Stationary Vehicle Warning (SVW)
- Green Light Optimal Speed Advisory (GLOSA)

In this work package, WP 3C, verification was planned, conducted and the results reported. As far as possible verification methods developed in WP1E were used.

The verification activities were performed at different levels and in different stages as described in the subsections below.

#### 5.2.9.1.1 Testing at developers’ premises

The following test were performed:

- The prototype retrofit solution was tested by Kapsch (WP2A)
- The “WCAE node” was tested by Actia (WP2B)
- The HMI solution was tested by AB Volvo (WP2C)

#### 5.2.9.1.2 Testing after integration into test vehicles

The following test were performed:

- The retrofit solution was tested after integration into AB Volvo FH Trucks and VCC XC90 test cars.
- The “WCAE Node” was tested after integration into the VCC XC90 test cars.
- The HMI solution was tested after integration into one AB Volvo FH Truck.

Additionally, software was developed for Android tablets, which were used in test vehicles not connected to the WP2C HMI solution.

The figure below gives a schematic overview of the integration into vehicles.

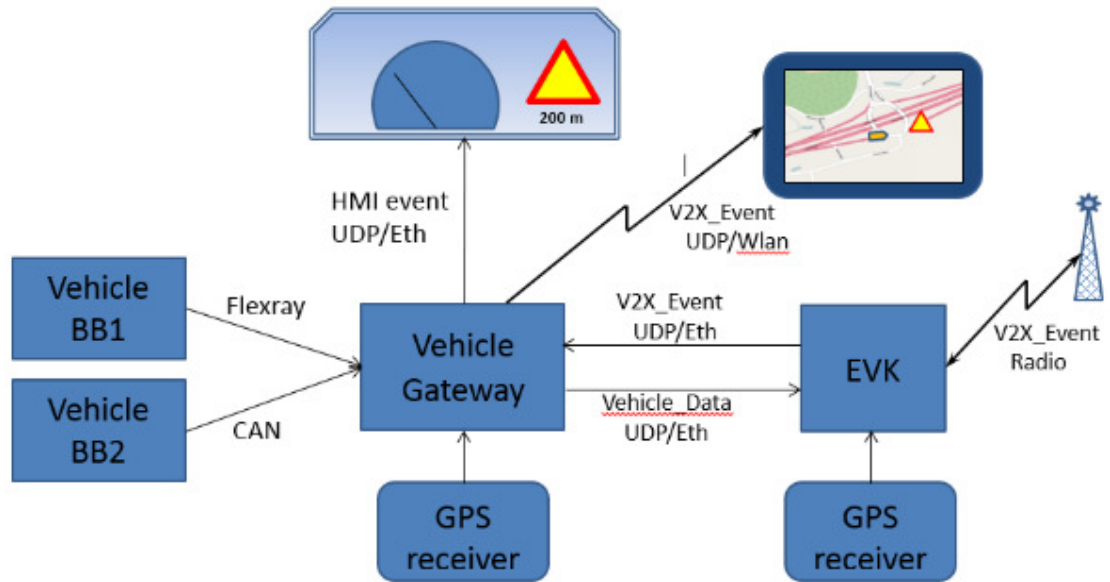

Figure 62: Module set-up of WCAE vehicles

#### 5.2.9.1.3 The RF Measurement Campaign (in June 2016)

Additional varication and testing within the WP3A scope was performed in the WCAE RF Measurement Campaign.

- In total, 29 persons participated from nine different companies: AB Volvo, VCC, Kapsch, Actia, LTH, SP/RISE, Ericsson, Bluetest and Chalmers.
- Lots of efforts were made by all attendees to plan and perform this week-long activity and to get everything running regarding 802.11p measurements.
- All included parties considered this RF measurement campaign successful regarding all measurements, phase steerable antenna, 802.11p, LTE, and 802.11p together simultaneously with LTE.
- The activity resulted in an enormous amount of data to be analysed by the project by selected resources (mainly VCC, AB Volvo and LTH) for future paper publications, Proof of Concepts, and evidence based data conclusions.



Figure 63: RF Measurement Campaign in June 2016.

### 5.2.9.2 Preparations for the Demonstration Days (August-September 2016)

Finally, test drives and verifications were performed as preparations for the WCAE/WV2X Demonstration Days. The actual demonstrations performed at this event are part of WP3B and described in another part of the WCAE Final Report.

Below some pictures showing the HMI prototype solution for the three studied V2X use cases (applications).

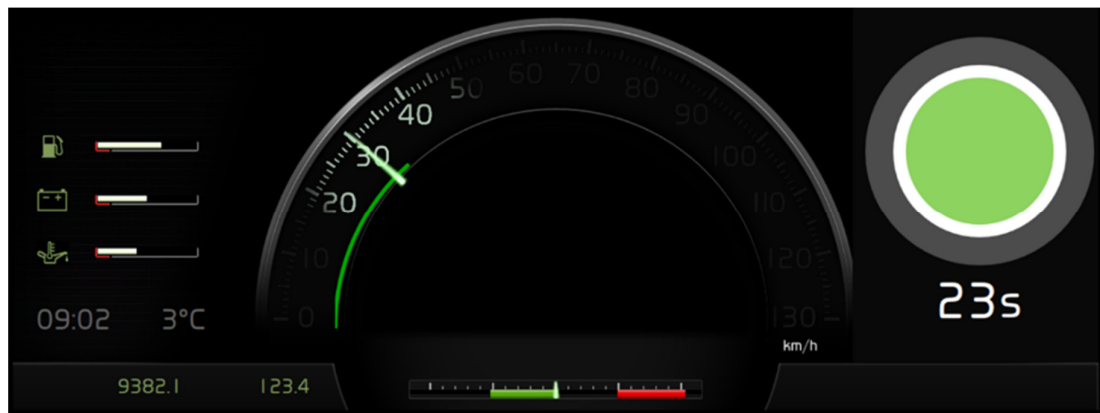

Figure 64: GLOSA application (use case)

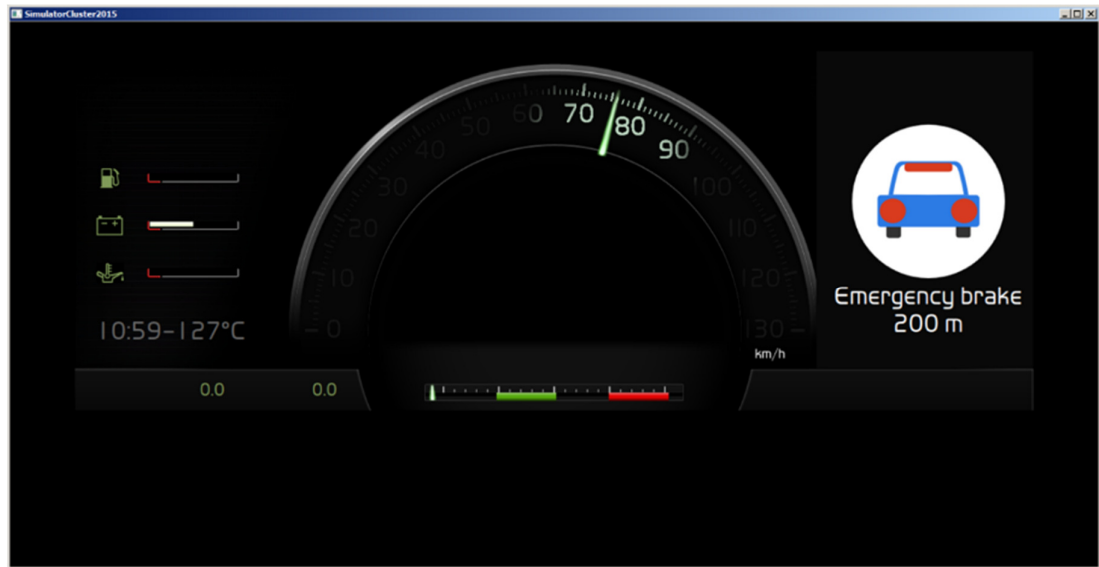

Figure 65: EEBL application (use case)

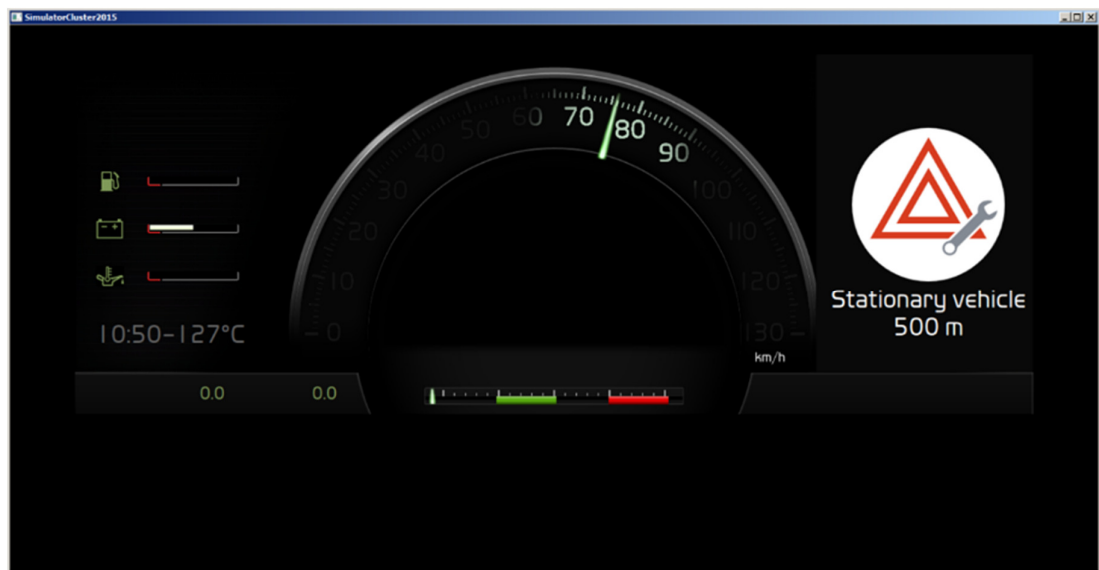

Figure 66: SVW application (use case)

### 5.2.9.3 Results

In this work package we used the by the WCAE project developed parts within WP2A, 2B and 2C covering communication modules from Kapsch (EVK-3300), Actia (VCM High/CEM3/TGWx) and AB Volvo HMI-concept in FDC (Full-Dynamic Cluster).

Our efforts in the project resulted in equipped vehicles which were verified in different stages in order to secure the later planned activity in WP3B, i.e. Demonstration Days which successfully were performed in week 39 2016 (28-29 September).



#### **5.2.9.4 Conclusions & Future Research**

The developed in-vehicle system is based on early adaptations and with methods produced by our project partner during time of the implementation of earlier WP's within WP2.

Results from the measurement activity also performed within this WP will also most likely be used for further analysis of collected RF-data and conclusions from this.

Future conference papers could be based from this as background information and a huge amount of data was gathered in this week-long activity including six vehicles (four cars + two trucks) equipped with logging instruments as well as cameras for synchronization of data logging to secure future analysing of the data.



## **5.2.10 WP3B: Demonstration of System in Vehicle**

### **5.2.10.1 Activities Performed**

The purpose of this work package (WP3B) was to demonstrate the three different day-one use cases (V2X use cases, or applications, according to ETSI IT-G5 and IEEE 802.11p, eg. GLOSA, EEBL & SVW, see below) installed in vehicles based on the outcome of WP2A, WP2B, and WP2C.

WP2A developed a prototype retrofit solution for V2X. In order to speed up the deployment of V2X services or add functionality to the existing population of vehicles, retrofit units are an option for vehicles that are delivered without embedded V2X functionality.

WP2B developed a prototype ECU, the “WCAE Node”, with mobile network capabilities, in-vehicle network (CAN, Flexray and Ethernet) interfaces, and an interface to the V2X prototype developed in WP2A.

WP2C developed a prototype HMI solution for Volvo Trucks with the purpose to properly visualize, evaluate and experiment with the V2X services made available in the project.

The V2X day one use cases (applications) studied in the WCAE project were:

- Emergency Electronic Brake Light (EEBL)
- Stationary Vehicle Warning (SVW)
- Green Light Optimal Speed Advisory (GLOSA)

In this work package, WP 3C, verification was planned, conducted and the results reported. As far as possible verification methods developed in WP1E were used.

The verification activities were performed at different levels and in different stages as described in the subsections below.

### **5.2.10.2 Demonstration object (parts) and partners**

The demonstration was based on the following parts:

- The prototype retrofit solution was demonstrated by Kapsch TrafficCom from WP2A
- The “WCAE node” was demonstrated and streamed by Actia from WP2B
- The HMI solution was developed and provided the Volvo Group from WP2C



### 5.2.10.3 Validation and Demonstration of scenarios and vehicles

The following use cases were performed during the demonstration:

- The retrofit solution was validated and demonstrated after integration into AB Volvo FH Trucks and VCC XC90 demo cars.
- The “WCAE Node” was demonstrated after integration and validation in the VCC XC90 demo cars.
- The HMI solution was tested after integration into one AB Volvo FH Truck.

Additionally, software was developed for Android tablets, which were used in the vehicle and scenario demonstration.

The figure below gives an overview of the vehicles which were used in the scenario demonstration.



*Figure 67 Preparation of Demonstration WCAE project vehicles*



#### 5.2.10.4 Demonstration map and run (in Sept. 2016)

Different runs were discussed before choosing the one below.

- In total, approx.. 150 pers. were invited to the two Demonstration Days (28-29/9,-16) and around 60 + 50 persons attended during these days (incl. project staff)
- First day, on Wednesday the 28<sup>th</sup> of September were more more of popular version of presentations while the second day (29<sup>th</sup>) was more of a deep-dived into details and scientific result given in parallel which continues demonstration runs in vehicles where the three different scenarios were demonstrated.



Figure 68 Demonstration run

### 5.2.10.5 Performing Demonstration Days (September 2016)

Project team visible in picture below:



*Figure 69: All team setup for Demonstration Days 2016*

### 5.2.10.6 Results

In this work package we used WCAE project developed parts from WP2A, WP2B and WP2C including communication modules from Kapsch (EVK-3300), Actia (VCM High/CEM3/TGWx) and AB Volvo HMI-concept in FDC (Full-Dynamic Cluster).

Our efforts in the project resulted in equipped vehicles which were verified in different stages in order to secure the later planned activity in WP3B, i.e. Demonstration Days which successfully were performed in week 39 2016 (28-29 September).

[www.wcae.se](http://www.wcae.se)



## **5.2.11 WP3C: Publication of Papers**

### **5.2.11.1 Activities Performed**

In this WP we have collected publications from work with major funding from WCAE and related work from the partners but performed with only minor funding from WCAE. Papers have been published in international well renowned journals, at international conferences as well as in the COST programs IC1004 and IRACON. In addition one licentiate thesis was defended, one PhD thesis is planned to be defended in June 2018. Also, one licentiate thesis in a related project was defended in 2017, where the results were used in WCAE.

All publications can be found in chapter 6.

### **5.2.11.2 Conclusions & Future Research**

The presented publications in chapter 6 describe the theoretical width of the work that formed the basis of WCAE. Of course, the publications do not cover all results in an applied project like this, but they give an indication that the work also is highly relevant from an international research point of view.



## 6. Dissemination and publications

### 6.1 Knowledge and results dissemination

The main mechanism for dissemination with the project partner organizations were the Project Seminars arranged in the project in cooperation between the FFI projects WV2X and WCAE. Apart from project team and steering group members, key individuals from the partner organizations participated in these seminars, and VINNOVA representatives were invited.

The subsections below show the agendas and other relevant information for these seminars. The presentations were, like other results from the project, stored on the Project SharePoint site, administered by VCC and accessible for the other project partners.

#### 6.1.1 WCAE/WV2X Seminar 2015-04-08

<b>WCAE &amp; WV2X Seminar – Agenda 2015-04-08</b>	
Time 09.30-15.00, Place: Volvo Car Corporation (VCC), Volvo Jakobs väg, Torslanda, Göteborg, Room: PVH5 "Hörsal B" (First go to: PVH Reception, see attached map in Outlook Invitation)	
09.30	Registration and Coffee/Tea
09.50	0) Welcome and Introduction – P-A Jörgner, Volvo Car Corporation (VCC) (10 min)
10.00	1) From Active Safety Systems to Connected Automation Katrin Sjöberg, AB Volvo (30 min)
10.30	2) Why 5.9 V2X? Adam Tengblad, Kapsch (20 min)
10.50	Break (Coffee/Tea) [20 min]
11.10	3) Market Trends Toward the Deployment of C-ITS – Environment Scan Report Taimoor Abbas, VCC (30 min)
11.40	4) What's left Before Deployment of C-ITS Can Start? Katrin Sjöberg, AB Volvo (20 min)
12.00	Lunch [1 h]
13.00	5) WCAE WP1C Update – Initial RLOS Measurements on Car Jan Carlsson, SP (20 min)
13.20	6) Vehicle-to-vehicle System Simulator Jan Carlsson, SP (20 min)
13.40	7) Stress Test of Vehicular Communication Transceivers Using Software Defined Radio Carl Gustafson, Lund University (20 min)
14.00	Break (Coffee/Tea) [20 min]
14.20	8) On Multilink Shadowing Effects in Measured V2V Channels on Highway Mikael Nilsson, VCC (20 min)
14.40	9) Wireless Communication as part of Architecture for Autonomous Driving Kent Melin, VCC (20 min)
15.00	Thank You & The End – P-A Jörgner, VCC

Figure 6.1: Agenda WCAE/WV2X Seminar, April 2015



### 6.1.2 WCAE/WV2X Demonstration Days 2016-09-28/29

This event also included, in parallel, V2X test drives for the audience with two AB Volvo FH test trucks and two VCC XC90 test cars.

<b>WCAE/WV2X Demonstration Days Seminar</b>	
<b>– Agenda 2016-09-28 (Day 1)</b>	
Time 09.30-15.10, Place: Volvo ATR Concept Studio at M1, Lindholmen, Göteborg	
09.30	Registration and Coffee/Tea
09.50	0) Welcome and Introduction – P-A Jörgner, Magnus Olbäck, Mikael Nilsson [10 min]
10.00	1) EU and US Standardization of c-ITS and Connected Automation Katrin Sjöberg, AB Volvo [30 min]
10.30	2) Channel characteristics for cooperative ITS and positioning Fredrik Tufvesson, Lund University [30 min]
11.00	Break (Coffee/Tea) [20 min]
11.20	3) Multiprobe Over-the-Air Test Setup for Cars: Introduction Mikael Nilsson, Volvo Cars and Kristian Karlsson, SP [20 min]
11.40	4) An ECU for wireless communication via 3G, LTE, Wi-Fi and V2X Lennart Strandberg, ACTIA Nordic AB [20 min]
12.00	Lunch [1 h]
13.00	5) ADAS and Cooperative Safety Adam Tengblad, Kapsch TrafficCom AB [40 min]
13.40	6) Autonomous Driving Cars in a Wireless Environment Kent Melin, Volvo Cars [30 min]
14.10	Break (Coffee/Tea) [20 min]
14.30	7) Mapping V2X Wireless Performance to System Specifications Russ Whiton, AB Volvo [30 min]
15.00	Wrap up – P-A Jörgner, Volvo Cars
15.10	End

Figure 6.2: Agenda WCAE/WV2X Demonstration Days, September 2016 (Day 1)

## WCAE/WV2X Demonstration Days Seminar – Agenda 2016-09-29 (Day 2)

Time 09.30-15.10, Place: Volvo ATR Concept Studio at M1, Lindholmen, Göteborg

- 09.30 Registration and Coffee/Tea
- 09.50 0) Welcome and Introduction – P-A Jörgner, Magnus Olbäck, Mikael Nilsson [10 min]
- 10.00 1) Channel Emulation Using Software Defined Radio (SDR)  
Dimitrios Vlastaras, Lund University [20 min]
- 10.20 2) A Simulation framework for V2V Wireless Systems at 5.9 GHz  
Carl Gustafson, Lund University [40 min]
- 11.00 Break (Coffee/Tea) [20 min]
- 11.20 3) Multiprobe Over-the-Air Test Setup for Cars: Introduction, Method & Results  
Mikael Nilsson, Volvo Cars and Kristian Karlsson, SP [60 min]
- 12.20 Lunch [1 h]
- 13.20 4) A Measurement Based Multilink Shadowing Model for V2V Network Simulations of  
Highway Scenarios  
Mikael Nilsson, Volvo Cars [30 min]
- 13.50 5) Simulations in the WCAE project  
Edith Condo Neira, SP [20 min]
- 14.10 Break (Coffee/Tea) [20 min]
- 14.30 6) Measurement Methods & Tools – WiFi & LTE  
Magnus Eek/Tai Huang, Volvo Cars [30 min]
- 15.00 Wrap up – P-A Jörgner, Volvo Cars
- 15.10 End

Figure 6.3: Agenda WCAE/WV2X Demonstration Days, September 2016 (Day 2)

The presentations can be found on the public web site: [www.wcae.se](http://www.wcae.se)



## 6.2 Publications

### 6.2.1 Journal papers

M. G. Nilsson, C. Gustafson, T. Abbas, and F. Tufvesson: A Path Loss and Shadowing Model for Multilink Vehicle-to-Vehicle Channels in Urban Intersections, manuscript in preparation for IET Communications

C. Gustafson, K. Mahler, L. Pauser, D. Bolin, F. Tufvesson: A Geometry-based Stochastic channel model for V2V intersection scenarios based on high-resolution measurements, manuscript in preparation for IEEE Transactions on Vehicular Communication

M. Nilsson, C. Gustafson, T. Abbas, F. Tufvesson, "A Measurement Based Multilink Shadowing Model for V2V Network Simulations of Highway Scenarios", IEEE Transactions on Vehicular Technology, Vol.66, Issue 10, pp 8632 – 8643, Oct. 2017, DOI: 10.1109/TVT.2017.2709258

M. Nilsson, P. Hallbjörner, N. Arabäck, B. Bergqvist, T. Abbas, F. Tufvesson: Measurement Uncertainty, Channel Simulation, and Disturbance Characterization of an Over-the-Air Multi-Probe Setup for Cars at 5.9 GHz, IEEE Transactions on Industrial Electronics, Vol. 62, No. 12, pp. 7859-7869, 2015.

C. Gustafson, T. Abbas, D. Bolin, F. Tufvesson: Statistical Modeling and Estimation of Censored Pathloss Data, IEEE Wireless Communications Letters, Vol. 4, No. 5, 2015.

### 6.2.2 Conference papers

Christian Nelson, Nikita Lyamin, Alexey Vinel, Carl Gustafson, Fredrik Tufvesson, Lund University: Geometry Based Channel Models with Cross- And Autocorrelation for Vehicular Network Simulations, IEEE Vehicular Technology Conference, Porto, Portugal, May 2018, accepted

Dimitrios Vlastaras, Russ Whiton and Fredrik Tufvesson: A model for power contributions from diffraction around a truck in Vehicle-to-Vehicle communications, *15th International Conference on Intelligent Transport Systems (ITS) Telecommunications, Warsaw, Poland, May 2017.*

C.Gustafson, D. Bolin F. Tufvesson: Modeling the Polarimetric mm-wave Propagation Channel using Censored Measurements, In Proc. IEEE Globecom, Washington D.C., Dec 2016.

M. Nilsson, D. Vlastaras, T. Abbas, B. Bergqvist, F. Tufvesson: On Multilink Shadowing Effects in Measured V2V Channels on Highway, 9th European Conference on Antennas and Propagation (EuCAP) 2015, Lisbon, Portugal, 2015-04-12.

D. Vlastaras, S. Malkowsky, F. Tufvesson: Stress Test Of Vehicular Communication Transceivers Using Software Defined Radio, 81st Vehicular Technology Conference, Glasgow, Scotland, 2015-05-11.

Strom, E.G.; Sjoberg, K.; Carlsson, J.; Majidzadeh, A.: Requirements and test methods for vehicular antenna systems supporting cooperative ITS applications, Microwaves for Intelligent Mobility (ICMIM), 2015 IEEE MTT-S International Conference on, 2015, DOI: 10.1109/ICMIM.2015.7117939D.

Vlastaras, T. Abbas, M. Nilsson, R. Whiton, M. Olbäck, F. Tufvesson: Impact of a Truck as an Obstacle on Vehicle-to-Vehicle Communications in Rural and Highway Scenarios, 6th International Symposium on Wireless Vehicular Communications, Vancouver, Canada, 2014-09-14.

### 6.2.3 COST IC1004/COST IRACON papers



M. Hofer, Z. Xu, D. Vlastaras, B. Schrenk, D. Löschenbrand, F. Tufvesson, T. Zemen, “Real-Time Implementation and Validation of a Geometry-Based Stochastic Channel Model”, COST IRACON, Graz, Austria, September 2017.

Christian Nelson, Nikita Lyamin, Alexey Vinel, Fredrik Tufvesson, “Geometry Based Channel Models with Cross- and Auto-correlation for Simulations of V2V Wireless Networks”, COST IRACON, Lund, Sweden, May 2017.

Mikael G. Nilsson, Carl Gustafson, Taimoor Abbas, Fredrik Tufvesson, “A Measurement Based Multilink Shadowing Model for V2V Network Simulations of Highway Scenarios”, COST IRACON, Lille, France, May 2016.

Mikael G. Nilsson, Dimitrios Vlastaras, Taimoor Abbas, Björn Bergqvist, and Fredrik Tufvesson, “On Multilink Shadowing Effects in Measured V2V Channels on Highway”, COST IC1004, Dublin, Ireland, Jan 2015.

Dimitrios Vlastaras, Steffen Malkowsky, and Fredrik Tufvesson, “Stress Test Of Vehicular Communication Transceivers Using Software Defined Radio”, COST IC1004, Dublin, Ireland, Jan 2015.

Dimitrios Vlastaras, Taimoor Abbas, Mikael Nilsson, Russ Whiton, Magnus Olbäck and Fredrik Tufvesson, “Impact of a Truck as an Obstacle on Vehicle-to-Vehicle Communications in Rural and Highway Scenarios” COST IC1004, Aalborg, Denmark, May 2014.

Mikael Nilsson, Paul Hallbjörner, Niklas Arabäck, Björn Bergqvist, Taimoor Abbas and Fredrik Tufvesson, “Experiments and Analysis of Measurement Uncertainty of an Over-the-Air Multi-Probe Setup for Cars at 5.9 GHz”, COST IC1004, Aalborg, Denmark, May 2014.

#### **6.2.4 Technical report**

C. Gustafson, T. Abbas, D. Bolin, F. Tufvesson: Tobit Maximum-likelihood estimation of Censored Pathloss Data, Technical report, Dept. of Electrical and Information Technology, Lund University, Sweden, ISSN 1402-8840, 2015

#### **6.2.5 Theses**

M. Nilsson: Verification of wireless communication performance and robustness for automotive applications, Dept. of Electrical and Information Technology, Lund University, Sweden, defence planned for June 2018.

D. Vlastaras: Vehicular Communication in Obstructed and Non Line-of-Sight Scenarios, Licentiate thesis, Dept. of Electrical and Information Technology, Lund University, Sweden, ISBN 978-91-7753-162-3, Jan 2017.

#### **6.2.6 Related papers from the partners, but where the main work is not directly paid by WCAE:**

##### **6.2.6.1 Journal papers**





E. Condo Neira, K. Karlsson, E. G. Ström, J. Carlsson, and A. Majidzadeh, "V2V Antenna Evaluation Method in a Simulated Measurement-Based Multipath Environment," submitted to IEEE Transaction on Antennas and Propagation, Dec. 2016.

K. Mahler; W. Keusgen; F. Tufvesson; T. Zemen; G. Caire, "Measurement-Based Analysis of Dynamic Multipath Propagation in Vehicular Communication Scenarios," IEEE Transactions on Vehicular Technology. Accepted, DOI: 10.1109/TVT.2016.2621239

K. Mahler; W. Keusgen; F. Tufvesson; T. Zemen; G. Caire, "Tracking of Wideband Multipath Components in a Vehicular Communication Scenario", IEEE Transactions on Vehicular Technology, Vol 66, issue 1, pp 15-25, 2017, DOI: 10.1109/TVT.2016.2536999

L. Bernado, T. Zemen, F. Tufvesson, A. Molisch, C. F. Mecklenbrauker: Time- and Frequency-Varying K -Factor of Non-Stationary Vehicular Channels for Safety-Relevant Scenarios, IEEE Transactions on Intelligent Transportation Systems, Vol. 16, No. 2, pp. 1007-1017, 2015.

T. Abbas, K. Sjöberg, J. Kåredal, F. Tufvesson: A Measurement Based Shadow Fading Model for Vehicle-to-Vehicle Network Simulations, International Journal of Antennas and Propagation, Vol. 2015, pp. 190607-, 2015.

T. Abbas, J. Nuckelt, T. Kürner, T. Zemen, C. Mecklenbräuker, F. Tufvesson: Simulation and Measurement Based Vehicle-to-Vehicle Channel Characterization: Accuracy and Constraint Analysis, IEEE Transactions on Antennas and Propagation, Vol. 63, No. 7, pp. 3208-3218, 2015.

D. Vlastaras, T. Abbas, D. Leston, F. Tufvesson: Vehicle Detection through Wireless Vehicular Communication EURASIP Journal on Wireless Communications and Networking, pp. 146-, 2014.

R. He, A. Molisch, F. Tufvesson, Z. Zhong, B. Ai, T. Zhang: Vehicle-to-Vehicle Propagation Models With Large Vehicle Obstructions Intelligent Transportation Systems, IEEE Transactions on, Vol. 15, No. 5, pp. 2237-2248, 2014.

L. Bernado, T. Zemen, F. Tufvesson, A. Molisch, C. F. Mecklenbrauker: Time- and Frequency-Varying K -Factor of Non-Stationary Vehicular Channels for Safety-Relevant Scenarios, Intelligent Transportation Systems, IEEE Transactions on, No. 99, 2014.

#### **6.2.6.2 Conference papers**

K. Mahler; W. Keusgen; F. Tufvesson; T. Zemen; G. Caire, "Propagation Channel in a Rural Overtaking Scenario with Large Obstructing Vehicles", 2016 IEEE 83rd Vehicular Technology Conference (VTC Spring), Nanjing, China, May 2016

K. Karlsson, J. Carlsson, , M. Larsson, C. Bergenheim, "Evaluation of the V2V Channel and Diversity Potential for Platooning Trucks," EuCAP, 10th European Conference on Antennas and Propagation, Davos, Switzerland, 10-15 Apr., 2016.

M. Larsson, F. Warg, K. Karlsson, M. Jonsson, "Evaluation of a Low-Overhead Forwarding Algorithm for Platooning," ICVES2015 - International Conference on Vehicular Electronics and Safety, Yokohama, JAPAN, Nov. 5-7, 2015.

M. Kildal, J. Kvarnstrand, J. Carlsson, A. A. Glazunov, A. Majidzadeh, P.-S. Kildal, "Initial Measured OTA Throughput of 4G LTE Communication to Cars with Roof-Mounted Antennas in 2D Random-LOS", ISAP 2015 International Symposium on Antennas and Propagation, Hobart, Tasmania, Australia, 9-12 Nov., 2015.

K. Mahler; W. Keusgen; F. Tufvesson; T. Zemen; G. Caire, "Propagation of Multipath Components at an Urban Intersection, Vehicular Technology Conference (VTC Fall), 2015 IEEE 82<sup>nd</sup>, 2015, DOI: 10.1109/VTCFall.2015.7391099

M. Larsson, M. Jonsson, K. Karlsson, C. Bergenheim and T. Larsson, "Curvature based Antenna Selection Method Evaluated Using the Data Age Metric and V2V Measurements," in Communication



Workshop (ICCW), 2015 IEEE International Conference on, pp. 2356-2362, London, England, 8-12 June, 2015.

E. C. Neira, J. Carlsson, K. Karlsson, E. G. Ström, “Combined LTE and IEEE 802.11p Antenna for Vehicular Applications,” EuCAP, 9th European Conference on Antennas and Propagation, Lisbon, Portugal, 12-17 Apr., 2015.

K. Karlsson, M. Larsson, S. Wickström, G. Ledfelt, M. Olbäck, R. Whiton and J. Rogö, “On the Effect of Vertical Spatial Diversity on V2V Communication for Three Different Platooning Scenarios,” EuCAP, 9th European Conference on Antennas and Propagation, Lisbon, Portugal, 12-17 Apr., 2015.

E. G. Ström, K. Sjöberg, J. Carlsson, A. Majidzadeh, “Requirements and test methods for vehicular antenna systems supporting cooperative ITS applications,” 2015 IEEE MTT-S International Conference on Microwaves for Intelligent Mobility (ICMIM), Germany, 27-29 Apr., 2015.

P.-S. Kildal, J. Carlsson, A. Majidzadeh, A. A. Glazunov, “Cost-Effective Measurement Setups for Testing Wireless Communication to Vehicles in Reverberation Chambers and Anechoic Chambers,” 2014 IEEE Conference on Antenna Measurements & Applications (CAMA), Antibes, France, 16-19 Nov. 2014.

M. Gan, Z. Xu, V. Shivaldova, A. Paier, F. Tufvesson: A ray tracing algorithm for intelligent transport systems in tunnels, in Proc. IEEE 6th International Symposium on Wireless Vehicular Communications (WiVeC), 2014, Vancouver, Canada, Sept. 2014

P. Ankarson, U. Carlberg, J. Carlsson, S. Larsson, B. Bergqvist “Impact of Different Interference Types on an IEEE 802.11p Communication Link Using Conducted Measurement”, EMC Europe 2014, Gothenburg, Sweden, 1-4 Sept., 2014.

R. He, A. Molisch, F. Tufvesson, Z. Zhong, B. Ai, T. Zhang: Vehicle-to-vehicle channel models with large vehicle obstructions, Communications (ICC), 2014 IEEE International Conference on, Sidney, Australia, pp. 5647-5652, 2014-06-10.

E. C. Neira, U. Carlberg, J. Carlsson, K. Karlsson, E. G. Ström, “Evaluation of V2X Antenna Performance Using a Multipath Simulation Tool”, EuCAP, 8th European Conference on Antennas and Propagation, The Hague, The Netherlands, 6-11 Apr., 2014.

K. Karlsson, J. Carlsson, M. Olbäck, T. Vukusic, R. Whiton, S. Wickström, G. Ledfelt, J. Rogö, “Utilizing Two-Ray Interference in Vehicle-to-Vehicle Communications”, EuCAP, 8th European Conference on Antennas and Propagation, The Hague, The Netherlands, 6-11 Apr., 2014.

### 6.2.6.3 Theses

Condo Neira, E., “Antenna Evaluation for Vehicular Applications in Multipath Environment. Licentiate thesis, Chalmers University of Technology, Gothenburg, Sweden, April 2017.



## 7. Conclusions and future research

Conclusions and further research ideas are documented per WP in chapter 5 above. This chapter draws some general conclusions and identifies some further research ideas summarized for the whole FFI WCAE project.

The six project partners has gained deeper understanding about the ETSI ITS-G5 standard for C-ITS and how to integrate the technologies into vehicles.

Together, we have defined, implemented and tested a set of use-case for C-ITS. We have evaluated many different testmethods, some suitable to be used specific period of time during vehicle development cycle. It's clear that simulations are an importat way forward of assessing the wireless system in early stages of the development.

We have shown that great and dedicated teamwork between projectpartners can make a difference and the project has published many valuable contributions to the research industry.

Market initiatives has started to implement C-ITS technologies for both light and heavy vehicles. Further research will involve even deeper focus on wireless testmethods and investigation of new technologies which are pushing aggressively to be able to catch up with e.g. ETSI ITS-G5.

## 8. Participating parties and contact persons

The following organizations were part of this project (listed below in alphabetical order with main contact persons):

- Actia Nordic AB: Lennart Strandberg, Andreas Bergvall
- Kapsch TrafficCom AB: Adam Tengblad, Maria Borgmark
- Lund University: Fredrik Tufvesson, Carl Gustafson
- Mecel AB: Anders Eliasson
- SP/RISE: Christer Karlsson, Kristian Karlsson
- Volvo Car Corporation<sup>2</sup>: Hans Alminger, Magnus Eek, Mikael Nilsson, Per-Anders Jörgner
- Volvo Group<sup>3</sup>: Niclas Nygren, Hossein Zakizadeh, Magnus Olbäck

---

<sup>2</sup> Volvo Personvagnar AB

<sup>3</sup> AB Volvo



## 9. Annex

### 9.1 References

- [1] FFI Application to Vehicle Development: Wireless Communication in Automotive Environment (WCAE), AnnSofie Ruuth VCC, 2014-06-13.

Note: Further references can be found in 5.2 and in the end of each workpackage.

### 9.2 Terminology

3G	3 <sup>rd</sup> Generation mobile networks
4G	4 <sup>th</sup> Generation mobile networks
5G	5 <sup>th</sup> Generation mobile networks
AUTOSAR	AUTomotive Open System ARchitecture
API	Application Programming Interface
BLE	Bluetooth Low Energy
BLER	Block Error Rates
BSM	Basic Safety Message
BTP	Basic Transport Protocol
C2C	Car-to-Car
C2D	Car-to-Device
C2I	Car-to-Infrastructure
C2X	Car-to-everything (car to other cars, infrastructure, etc.)
CACC	Cooperative Adaptive Cruise Control
CAM	Cooperative Awareness Messages
CPU	Central Processing Unit
C-ITS	Cooperative Intelligent Transport Systems
DENM	Decentralized Environmental Notification Messages
DFSS	Design For Six Sigma
DMAIC	Define, Measure, Analyze, Improve, Control
DPR	Design Pre-Requisites
DSRC	Dedicated Short-Range Communications
DUT	Device Under Test
DVM	Design Verification Methods
EEBL	Emergency Electronic Brake Light
EIRP	Effective Isotropic Radiated Power
ETSI	European Telecommunications Standards Institute
EVK	Evaluation kit
FDC	Full Dynamic Cluster
FFI	Fordonsstrategisk Forskning & Innovation
FLDB	Facilities Layer Database
GLOSA	Green Light Optimal Speed Advisory
GNSS	Global Navigation Satellite System
HMI	Human Machine Interface
HUD	Head Up Display
IC	Instrument Cluster
IEEE	Institute of Electrical and Electronics Engineers
IETF	Internet Engineering Task Force



IP	Internet Protocol
ITS	Intelligent Transport Systems
ITS-G5	ETSI group responsible for ITS standardization
KPI	Key Performance Indicator
LDM	Local Dynamic Map
LLC	Logical Link Control
LOS	Line of Sight
LTE	Long Term Evolution
LU	Lund University
MAC	Media Access Control
MIMO	Multiplex Input Multiple Output
MISO	Multiplex Input Single Outputs
MoU	Memorandum of Understanding
MPS	Multipath Propagation Simulator
OEM	Original Equipment Manufacturer (here automaker)
OLOS	Obstructed Line-Of-Sight
OSI	Open Systems Interconnect
OTA	Over The Air
OWD	One Way Delay
PHY	Physical layer
RISE	Research Institutes of Sweden
RSRP	Reference Signal Received Power
RSRQ	Reference Signal Received Quality
RX	Receiver
SAE	Society of Automotive Engineers
SAM	Smart Antenna Module
SDVM	System Device Verification Method
SID	Secondary Information Display
SIMO	Single Input Multiple Output
SNR	Signal to Noise Ratio
SP	Sveriges Tekniska Forskningsinstitut
SPAT	Signal Phase And Timing
SVW	Stationary Vehicle Warning
SWRS	Software Requirement Specification
TCP	Transmission Control Protocol
TX	Transmitter
UDP	User Datagram Protocol
US	United States
VCC	Volvo Car Corporation
V2I	Vehicle-to-Infrastructure
V2V	Vehicle-to-Vehicle
V2X	Vehicle-to-everything (vehicle to other vehicles, infrastructure, etc.)
VCC	Volvo Car Corporation
VGTT	Volvo Group Trucks Technology
VNA	Vector Network Analyser
WAVE	Wireless Access in Vehicular Environments (IEEE 1609 family of standards)
WC	Wireless Cable
WCAE	Wireless Communication in Automotive Environment
Wi-Fi	Wireless Fidelity
WP	Work Package



### 9.3 Report Authors

Many people have provided input to this report and several authors have written different chapters and parts. Thus, the language can vary and we hope that the readers have patience with this. The list below shows the main author or authors of the different parts of the report.

<b>Chapter/Section</b>	<b>Author/Authors</b>
1, 2, 3, 4 & 5.1	P-A Jörgner, Magnus Eek, VCC
5.2.1	Magnus Eek, Anton Skårbratt VCC
5.2.2	Kristian Karlsson, SP/RISE
5.2.3	Jan Carlsson & Kristian Karlsson, SP/RISE
5.2.4	Fredrik Tufvesson, Lund University and Mikael Nilsson, VCC.
5.2.5	Anton Skårbratt, Magnus Eek VCC
5.2.6	Maria Borgmark & Martin Krutzsch, Kapsch
5.2.7	Lennart Strandberg & Linus Conradson, Actia
5.2.8	Filip Frumerie & Magnus Olbäck, AB Volvo
5.2.9 & 5.2.10	Magnus Olbäck, AB Volvo
5.2.11	Fredrik Tufvesson, Lund University
6, 7, 8 & 9	P-A Jörgner, Magnus Eek VCC